



DVKR EXHAUST AIR VALVE

AIR MANAGEMENT SYSTEMS

PRODUCT PROPERTIES

DVKR with integrated connection bush and retaining ring

- Available in diameter 100, 125, 150/160 and 200mm.
- Manufactured from white polypropylene (RAL 9010).
- The valve is difficult to ignite (Will not burn with open flame)
- The valve material has a melting point between 150-180 °C
- The valve resists temperatures up to 110 °C without deformation
- High valve body improving air flow/less noise
- Closed disc
- No leakage between valve body and connection bush
- Connection bush also adapted for false ceiling panels
- Variable volume flow control
- Unique locking system between connection bush and valve body
- Suitable for rooms with high air humidity (e.g. kitchen, bathroom)
- Simple removal for cleaning

SPECIFICATIONS

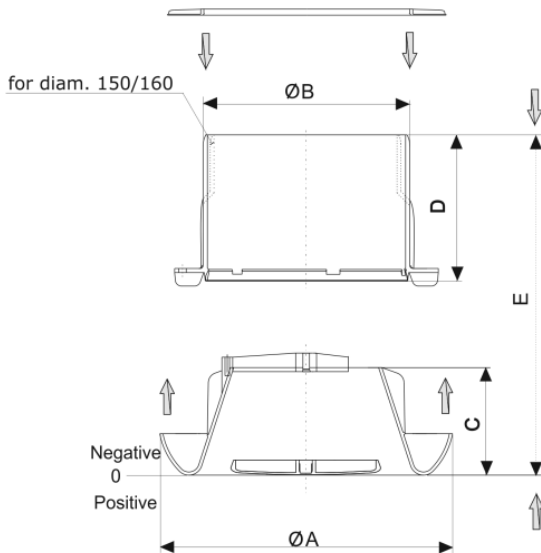

DVKR	A	B	C	D	E
100	141	99.5	52	70.5	84.5
125	167	124.5	52.5	70.5	84.5
150	202	149.5	52.5	70.5	84.5
160	202	159.5	52.5	70.5	84.5
200	240.3	199.5	52.0	70.5	84.5

PRESSURE LOSS

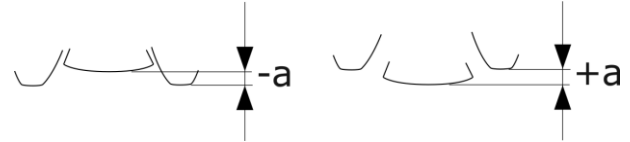

DVKR 100 mm

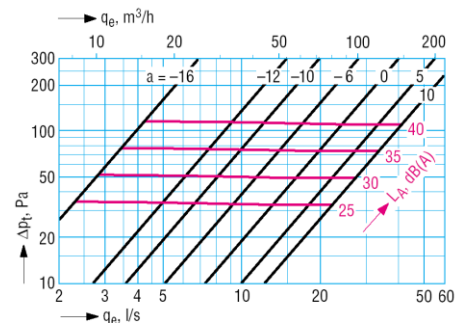

DVKR 125 mm

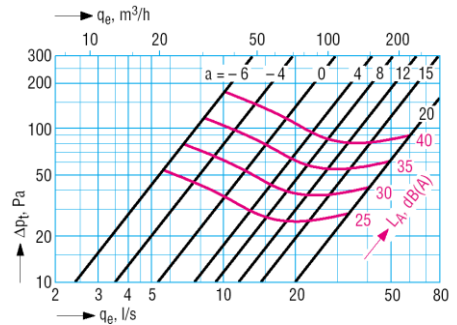

DVKR 150/160 mm

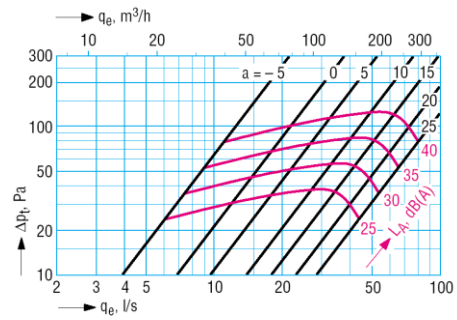

DVKR 200 mm

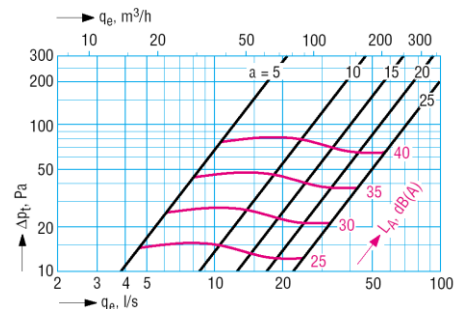

LIABILITY:

The information contained in this brochure was current on the publication date. DEC INTERNATIONAL reserves the right to make changes in details at any time without prior notice. In order to avoid misunderstandings, any interested party is advised to contact DEC INTERNATIONAL checking for any changes in materials and/or information after this brochure was published.

PLEASE NOTICE:

The consultant is responsible for the actual installation and mounting of the product. The mentioned values with respect to temperatures are not appropriate to be used to determine the physical properties. These properties are also dependent on humidity and the temperature of the air inside and outside of the H.V.A.C. system.

TRADEMARKS:

DEC International and the DEC logo are trademarks, or registered trademarks of Dutch Environment Corporation BV in the Netherlands and/or other countries.



DVKR EXHAUST AIR VALVE

AIR MANAGEMENT SYSTEMS

Mounting instructions

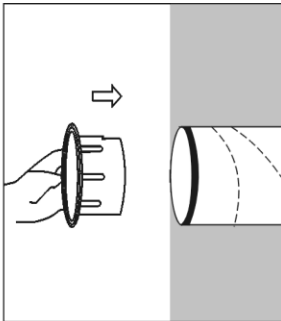

Installation of connection bush in wall

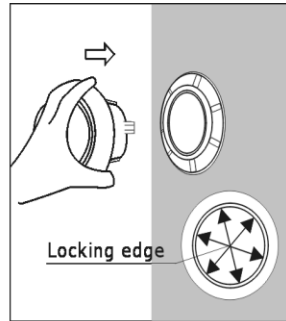

Installation valve in connection bush in wall. Ensure that one of the "valve wings" points towards the centre of a locking edge

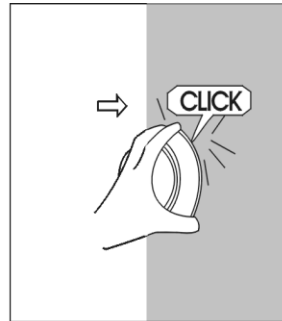

Press the valve until it clicks into position

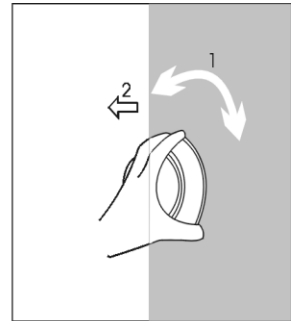

Removing the valve: rotate in either direction until valve disengages from connection bush. Pull straight out

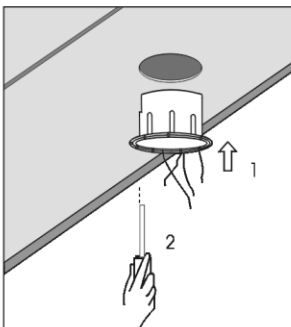

Installation of connection bush in false ceiling. Fixate with screws

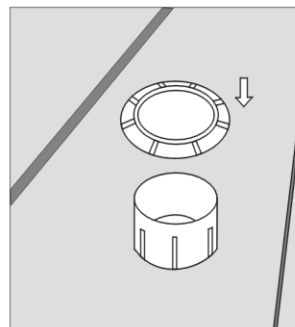

Installation of retaining ring for false ceiling panel

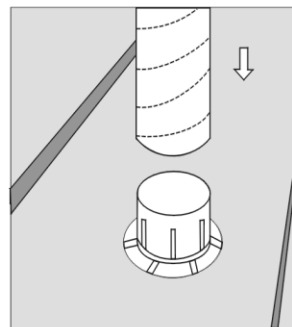

After mounting flexible duct on connection bush:
1. Tape off with alu tape
2. Fixate with clamps

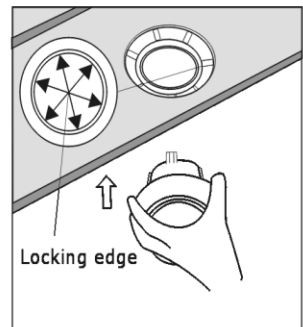

Installation of valve in connection bush. Ensure that one of the "valve wings" points towards the centre of a locking edge

LIABILITY:

The information contained in this brochure was current on the publication date. DEC INTERNATIONAL reserves the right to make changes in details at any time without prior notice. In order to avoid misunderstandings, any interested party is advised to contact DEC INTERNATIONAL checking for any changes in materials and/or information after this brochure was published.

PLEASE NOTICE:

The consultant is responsible for the actual installation and mounting of the product. The mentioned values with respect to temperatures are not appropriate to be used to determine the physical properties. These properties are also dependent on humidity and the temperature of the air inside and outside of the H.V.A.C. system.

TRADEMARKS:

DEC International and the DEC logo are trademarks, or registered trademarks of Dutch Environment Corporation BV in the Netherlands and/or other countries.