



NEW

LINEO RANGE

In-line mixed flow fans





VORTICE S.p.A. is part of a multinational group, **VORTICE GROUP**, which operates through its own companies or local distributors in over 90 countries worldwide and has a rich product portfolio that guarantees air quality and climate comfort. The headquarters of VORTICE S.p.A are in Tribiano (Milan).



VORTICE GROUP also includes:

[1]
VORTICE LIMITED, the UK subsidiary of VORTICE S.p.A., founded in 1977 with headquarters in Burton upon Trent.

[2]
VORTICE INDUSTRIAL, born from the acquisition in 2010 of Loran srl, based in Isola della Scala (VR).

[3]
VORTICE VENTILATION SYSTEM, a company inaugurated in 2013 with headquarters in Changzhou, China.

[4]
VORTICE LATAM S.A., based in Alajuela in Costa Rica, established in 2012.

[5]
CASALS VENTILACIÓN AIR INDUSTRIAL S.L., historic Spanish brand, based in Sant Joan de les Abadesses, Girona, acquired in 2019.



INDEX

Page 04

LINEO RANGE key features

Page 12

LINEO QUIET ES RANGE

In-line mixed flow fans equipped with EC Brushless motors



Page 18

LINEO QUIET RANGE

In-line mixed flow fans equipped with AC motors

Page 24

LINEO and LINEO ES RANGE key features

Page 28

LINEO RANGE

In-line mixed flow fans equipped with AC motors



Page 34

LINEO ES RANGE

In-line mixed flow fans equipped with EC Brushless motors

Certifications

The LINEO range products are CE marked according to the Directives and Regulations listed below. Their compliance with safety and EMC Standards is certified by IMQ.

Relevant Directives and Regulations for the CE Marking

- Machinery Directive (2006/42/CE)
- Low Voltage Directive (2014/35/EU)
- Electromagnetic Compatibility Directive (2014/30/EU)
- Ecodesign Directive (2009/125/EC)
- RoHS Directive (2011/65/EU)
- WEEE Directive (2012/19/EU)
- ERP Regulation No. 327/2011/EU

Electrical safety standards

- EN 60335-1
- EN 60335-2-80
- EN 62233
- EN 60529

Standards associated

with the Machinery Directive

- EN 60204-1
- EN 12100
- EN 12499
- EN 13857

Electromagnetic compatibility standards

- EN 55014-1
- EN 55014-2
- EN 61000-3-2
- EN 61000-3-3

LINEO RANGE

In-line mixed flow fans

The LINEO range products are “mixed flow” fans specifically designed for horizontal or vertical ducted installation

VENTILATION OF RESIDENTIAL,
COMMERCIAL OR INDUSTRIAL PREMISES.



They all have high levels of energy efficiency and meet the requirements of ERP Regulation 327/2011/EU. The fans in the renewed LINEO range boast

HIGH PERFORMANCE, LOW ENERGY CONSUMPTION, LOW NOISE EMISSIONS AND EASE OF INSTALLATION AND MAINTENANCE

placing them at the top of the category.

The LINEO range products are characterised by technopolymer enclosures for increased fire resistance safety class E2, according to EN ISO 11925-2:2010 and have a high degree of protection against water the classification only applies to a properly installed product

THE DESIGN

CONSTRUCTION FEATURES COMMON TO THE RANGE

The design consists of the following:

- a central motor mount which encloses the fan motor unit and houses the wiring devices externally, in an easily reachable position;
- the main body, fixed to a pair of end supports arranged for connection to the suction and delivery pipes, which is designed to rotate on its own axis to facilitate the housing of the product in small spaces and its wiring through the contacts positioned on its external surface;
- The ease with which it can be removed without altering the surrounding piping system, greatly speeds up and facilitates maintenance;

- the air flow rectifiers on the delivery side work in synergy with the upstream impeller, optimise the managed air flow, maximising performance and increasing efficiency, reducing the occurrence of vortices and minimising noise emissions;
- the mixed flow type impellers, combine the advantages of helical fans (high flow rates and flow around the axis of the impeller), with the high pressures of centrifugal fans; the directly coupled motors have shafts mounted on ball bearings, ensuring a virtually “maintenance free” operation;
- the timer in the T models allows the operation of the appliance to be programmed at maximum speed and ease at a range between 3' and 20', which can be set during installation.

KEY FEATURES

- high-performance, top-of-the-range;
- easy maintenance. Each component allows easy connection and disconnection with the nearby elements, and easy access to the inner components (motor-impeller) and their replacement. In the case of silenced products, the sound absorbing shells refitted at the end of the maintenance process, restore the original sound performance under test conditions;
- the motors have a minimum guaranteed life in continuous operation at maximum speed and at maximum ambient temperature of 30,000 or 40,000 hours depending on the type;
- completeness of the range, designed to offer the ideal product to meet the specific requirements of the system in terms of performance, consumption, quiet operation, operating costs and purchase price.

LINEO QUIET RANGE

In-line mixed flow fans

The **LINEO QUIET** range products are characterised by the use of a **sound-absorbing coating**, which is fully integrated in the outer casing and optimised to minimise environmental sound emissions.

**HIGH-LEVEL PERFORMANCE,
AT THE TOP OF THE RANGE.**

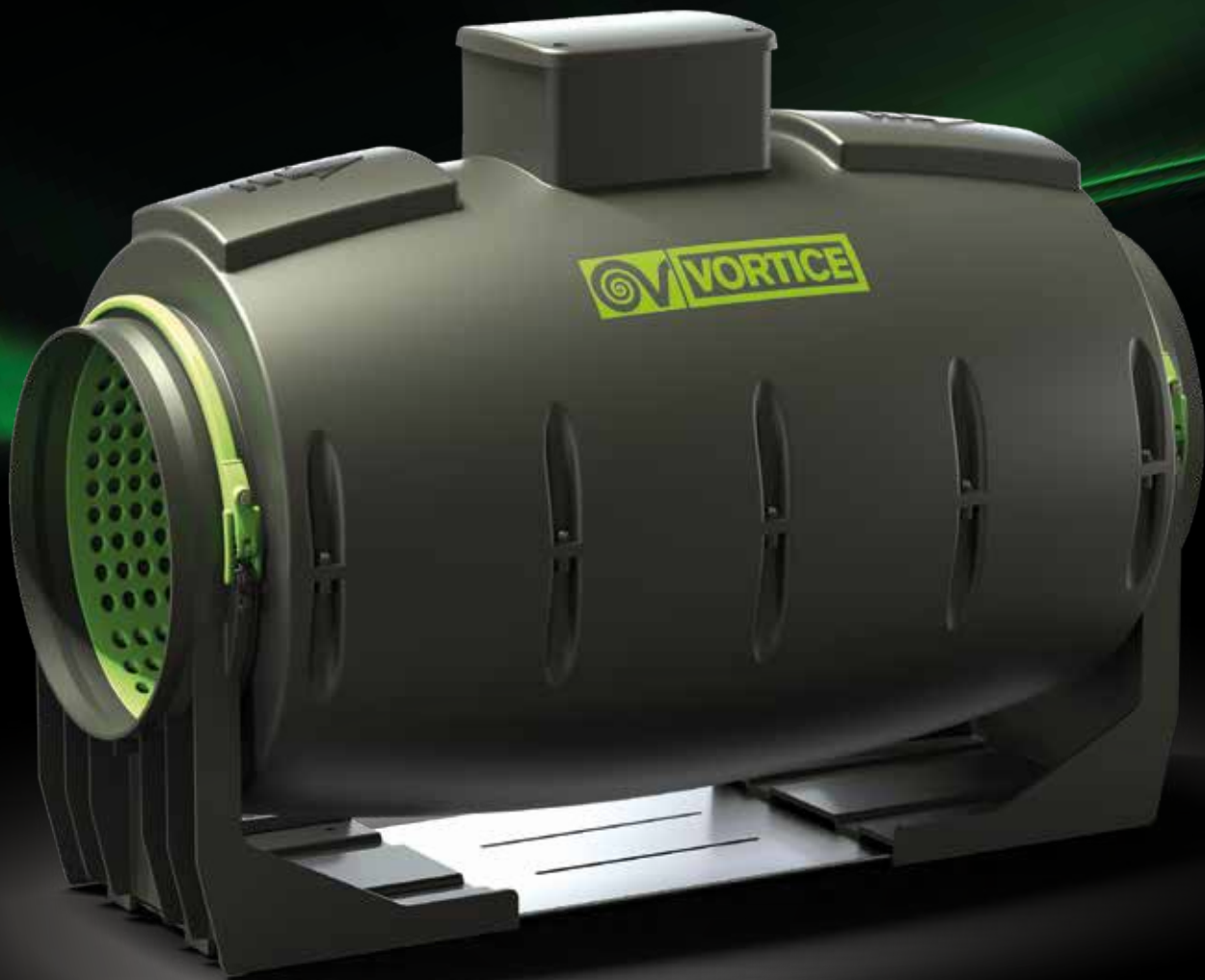

NEW

LINEO QUIET RANGE

In-line mixed flow fans



because energy
has to be....

SAVED

The impeller profiles,
the flow rectifiers and ogival profile
of the flow driver work in synergy with
the upstream impeller optimise the
managed air flow, maximising performance
and increasing efficiency, reducing
the occurrence of vortices and
minimising noise
emissions.

because silence
has to be....

BUILT

IMPELLER

Designed to reach the ERP
efficiency levels

CO-MOULDED SHELL

Easily removable during maintenance
without any effect on his sound
dampening effect

INLET NOZZLE

Dimensioned to sustain the product
in the wall and ceiling installation

DIVERGENT ELEMENT

It helps the impeller to increase
the performance

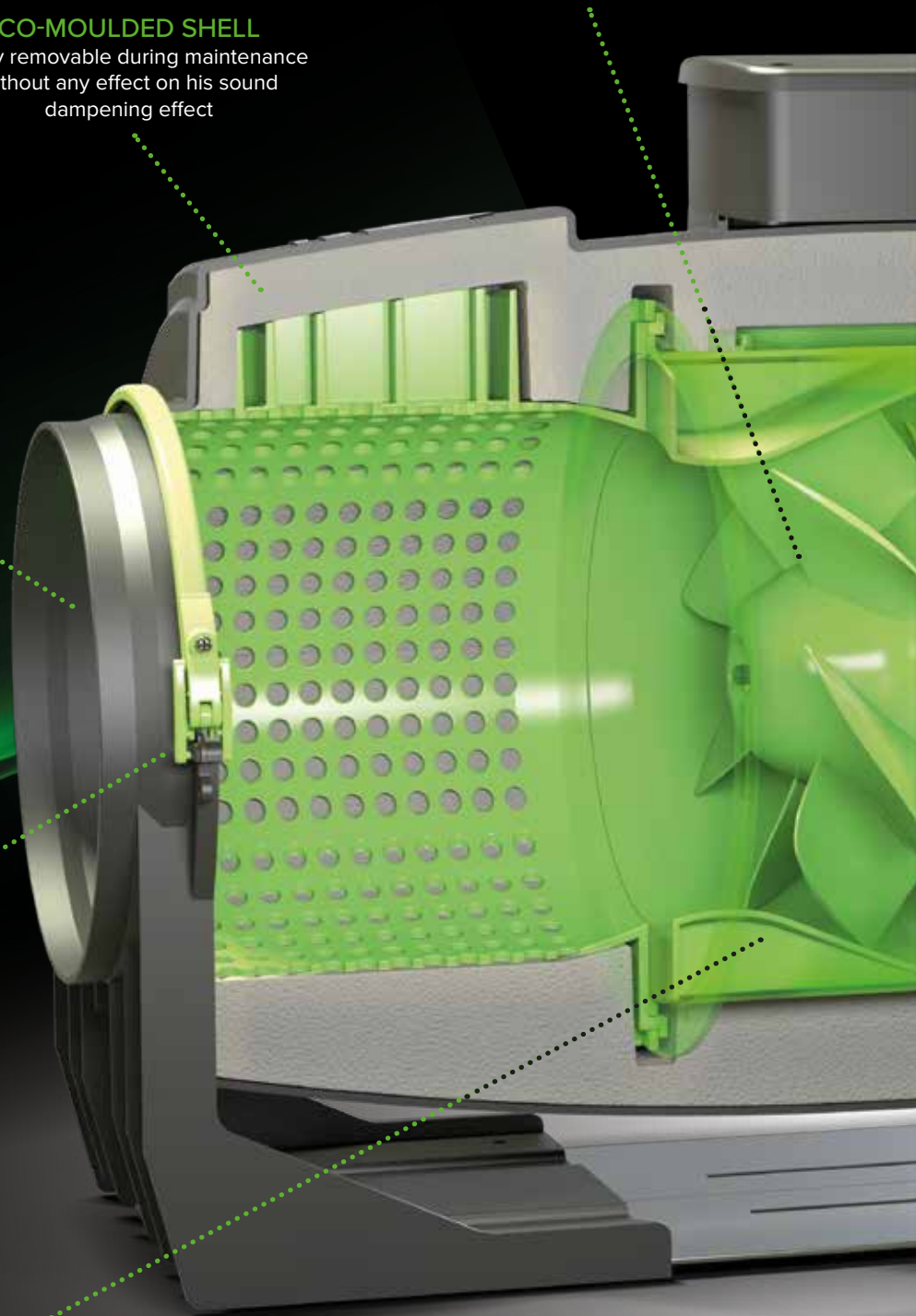

NEW

LINEO QUIET RANGE

In-line mixed flow fans



ELECTRIC BOX

Produced in a material granting electrical and fire resistance

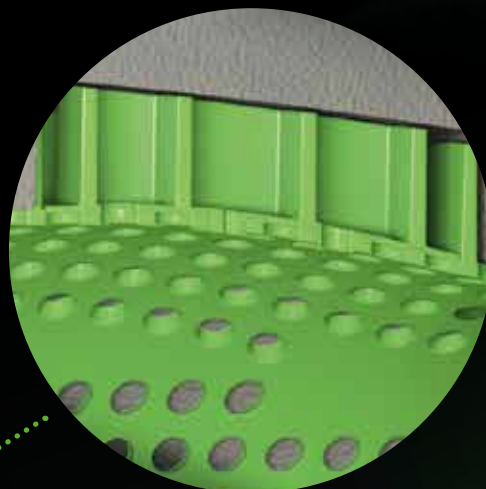

HELMHOLTZ RESONATOR GROUP

Passive sound dampener used to decrease the noise levels at predetermined frequencies

FLOW DRIVER

It corrects the airflow after the impeller and the rectifier, avoiding energy losses due to vortices

RECTIFIER BLADES

Designed with the impeller to rectify the airflow and avoid flow problems on the downstream part of the product

CO-MOULDED SHELL

Easily removable during maintenance without any effect on his sound dampening effect

LINEO QUIET ES RANGE

equipped with EC brushless motors

The products in the **LINEO QUIET ES** range differ from the corresponding versions of the LINEO QUIET range due to the use of electronically controlled 2 speed EC brushless (low consumption) motors. Each speed can be set at installation. Alternatively the units can run at 1 speed only, adjustable by user through 0-10V signal.



LINEO QUIET RANGE

equipped with AC motors

The **LINEO QUIET** range products are fitted with traditional AC motors, 2 or 3 speed depending on the model.



NEW

LINEO QUIET RANGE

In-line mixed flow fans



because environment
has to be....

SUSTAINED



TECHNICAL AND PERFORMANCE DATA - LINEO QUIET ES*

Models	Code	V~50/60HZ	W		RPM	Max Airflow		Max Pressure		Protection grade**	Max °C	KG
			4/6/8/10V			4/6/8/10V		4/6/8/10V				
			4/6/8/10V	4/6/8/10V		m³/h	l/s	mmH ₂ O	Pa			
LINEO 100 QUIET ES	17170	220-240	6,2	0,09	1140	135	37,5	3,5	34,3	IP45	60	3,8
			8,3	0,12	1450	175	48,6	5,8	56,9			
			14,7	0,18	2050	250	69,4	11,4	111,8			
			23	0,26	2510	300	83,3	24,8	243,2			
LINEO 125 QUIET ES	17171	220-240	6,6	0,10	1080	180	50	3,3	32,4	IP45	60	3,6
			8,8	0,12	1340	225	62,5	5,6	54,9			
			16	0,18	1865	320	88,9	11	107,9			
			24	0,26	2210	380	105,6	23,7	232,4			
LINEO 150 QUIET ES	17172	220-240	7,7	0,11	1015	250	69,4	4,6	45,1	IP45	60	5,4
			10,6	0,14	1240	305	84,7	7,5	73,6			
			20	0,24	1700	430	119,4	14,7	107,9			
			31	0,34	2030	515	143,1	24,2	237,3			
LINEO 160 QUIET ES	17173	220-240	7,7	0,11	1010	250	69,4	4,5	44,1	IP45	60	5,2
			10,6	0,14	1245	315	87,5	7,5	73,6			
			19,7	0,23	1685	435	120,8	14,4	141,2			
			31	0,34	2035	525	145,8	23,9	23,4			
LINEO 200 QUIET ES	17174	220-240	15,2	0,18	1380	570	158,3	8,6	84,3	IP45	50	8,6
			25,3	0,27	1705	720	200	13,9	136,3			
			52,4	0,52	2245	945	262,5	22,9	224,6			
			88	0,78	2700	1145	318,1	33,6	329,5			
LINEO 250 QUIET ES	17175	220-240	20	0,19	1365	750	208,3	10,1	99,1	IP45	50	13,4
			35	0,28	1680	940	261,1	15,6	153			
			75	0,60	2250	1250	347,2	26,6	260,9			
			125	0,97	2680	1485	412,4	37,5	367,8			
LINEO 315 QUIET ES	17176	220-240	42	0,31	1260	1400	388,9	12,9	126,5	IP45	50	28,3
			72	0,51	1560	1730	480,6	19,5	191,2			
			155	1,10	2070	2300	638,9	33,8	331,5			
			220	1,52	2350	2630	730,6	38,7	379,5			

* all data referred to supply at 50 Hz

** protection grade referred to ducted units

SOUND LEVELS - LINEO QUIET ES

Models	Code	SOUND POWER L _w dB (A)											
		INTAKE				SUPPLY				BREAKOUT			
		4V	6V	8V	10V	4V	6V	8V	10V	4V	6V	8V	10V
LINEO 100 QUIET ES	17170	37,7	42,9	53,4	55,6	38,1	43,6	54,2	58,2	30,4	36,4	45,3	51,4
LINEO 125 QUIET ES	17171	37,9	41,8	52	55	38,5	43,1	53,9	57,5	31,8	36,9	45,6	49,2
LINEO 150 QUIET ES	17172	40	44,7	53,2	58,2	40,9	45,9	53,8	58,2	34,2	39,1	46,5	51,5
LINEO 160 QUIET ES	17173	40,6	45,7	54,1	59,5	41,1	46,3	54	58,8	33	37,9	45,2	49,7
LINEO 200 QUIET ES	17174	48,7	54,3	60,8	65,5	48,1	53,6	60,4	65,2	40,2	45,3	51,4	56,3
LINEO 250 QUIET ES	17175	54,4	59,5	65,9	70,4	54,8	59,9	66,2	70,7	45,2	50,3	57,8	61,5
LINEO 315 QUIET ES	17176	61,9	66,2	71,8	74	58,7	63,4	69,4	72	54	56,3	65,1	68,8

Models	Code	SOUND PRESSURE L _p dB(A)*											
		INTAKE				SUPPLY				BREAKOUT			
		4V	6V	8V	10V	4V	6V	8V	10V	4V	6V	8V	10V
LINEO 100 QUIET ES	17170	20,2	25,4	35,9	38,1	20,6	26,1	36,7	40,7	9,9	15,9	25,8	30,9
LINEO 125 QUIET ES	17171	20,4	24,3	34,5	37,5	21	25,6	36,4	40	11,3	16,4	25,1	28,7
LINEO 150 QUIET ES	17172	22,5	27,2	35,7	40,7	23,4	28,4	36,3	40,7	13,7	18,6	26	31
LINEO 160 QUIET ES	17173	23,1	28,2	36,6	42	23,6	28,8	35,6	41,3	12,5	17,4	24,7	29,2
LINEO 200 QUIET ES	17174	31,2	36,8	43,3	48	30,6	36,1	42,9	47,7	19,7	24,8	30,9	35,8
LINEO 250 QUIET ES	17175	36,9	42	48,4	52,9	37,3	42,4	48,7	53,2	24,7	29,8	37,3	41
LINEO 315 QUIET ES	17176	44,4	48,7	54,3	56,5	41,2	45,9	51,9	54,5	33,5	35,8	44,6	48,3

* Calculated in free field conditions at 3 m distance

NEW

LINEO QUIET ES RANGE

In-line mixed flow fans equipped with EC Brushless motors



DIMENSIONS - LINEO QUIET ES

Models	Code	A	B	C	Ø D	E	F	G	H	L	Ø M	N	VERSION
LINEO 100 QUIET ES	17170	210	294,6	639	97	130	235	135	120	67,5	5,5	320	A
LINEO 125 QUIET ES	17171	210	294,6	504,5	122	130	235	135	120	67,5	5,5	320	A
LINEO 150 QUIET ES	17172	232	320,6	685	147	145	261,5	170	132	85	5,5	360	A
LINEO 160 QUIET ES	17173	232	320,6	570	156,5	145	261,5	170	135	85	5,5	360	A
LINEO 200 QUIET ES	17174	322,5	417,6	625,5	194,5	195	363,5	190	120	155	5,5	510	B
LINEO 250 QUIET ES	17175	318	411,9	751,5	243	189,5	363,5	200	70	170	6,5	604,55	B
LINEO 315 QUIET ES	17176	415,5	557,8	940	307	234	441	309	110	255	8,5	780	C

VERSION A

LINEO 100 QUIET ES - LINEO 125 QUIET ES - LINEO 150 QUIET ES - LINEO 160 QUIET ES

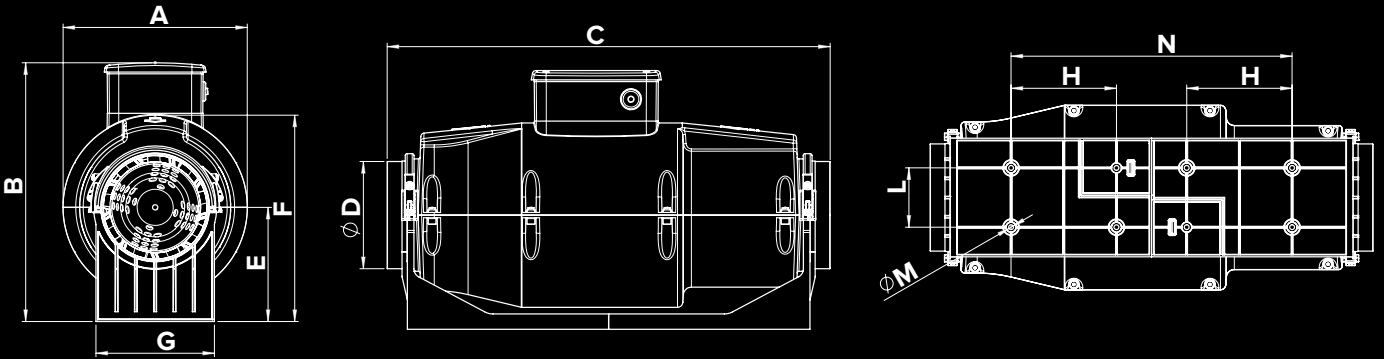

VERSION B

LINEO 200 QUIET ES - LINEO 250 QUIET ES

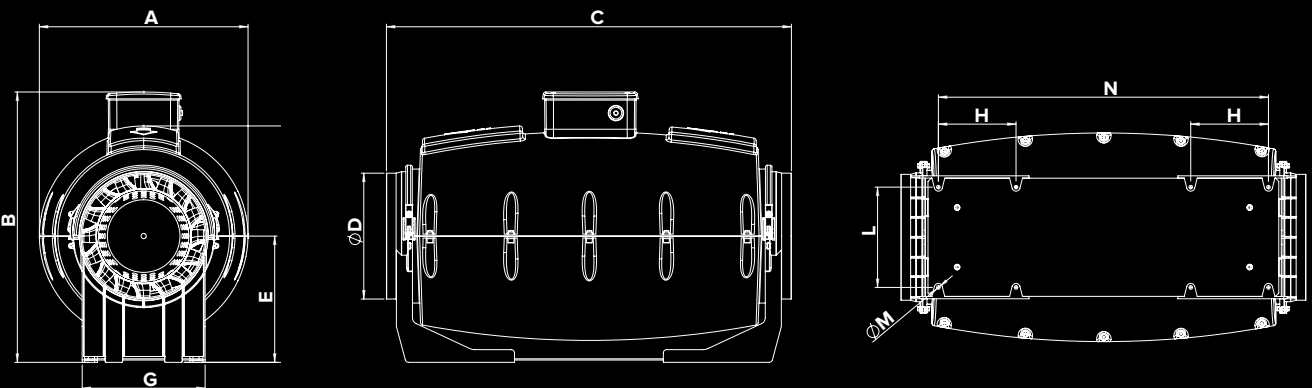

VERSION C

LINEO 315 QUIET ES

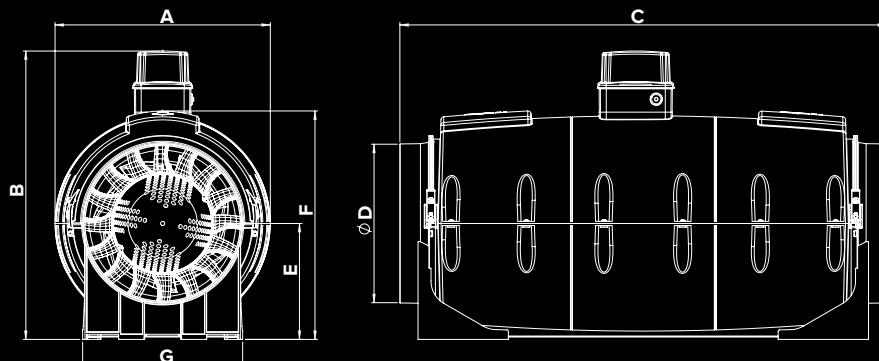



LINEO QUIET ES RANGE

NEW

In-line mixed flow fans equipped with EC Brushless motors

PERFORMANCE AND ABSORPTION CURVES - LINEO QUIET ES

LINEO 100 QUIET ES

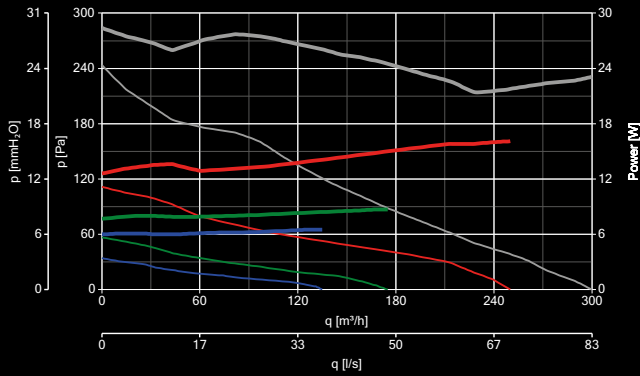

LINEO 125 QUIET ES

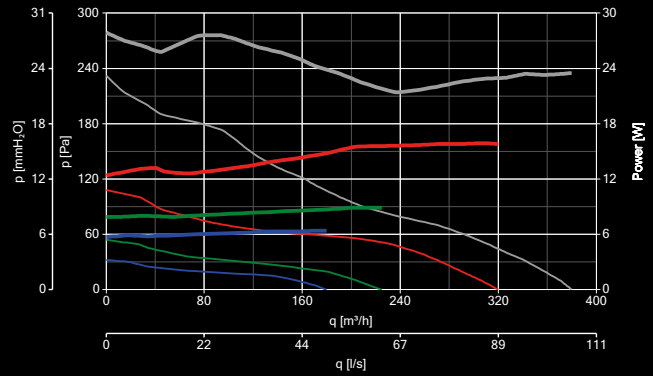

LINEO 150 QUIET ES

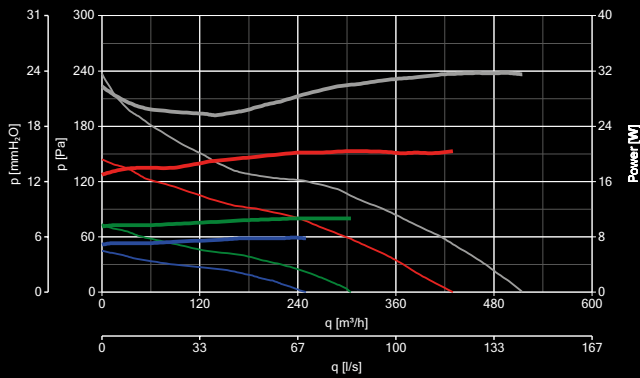

LINEO 160 QUIET ES

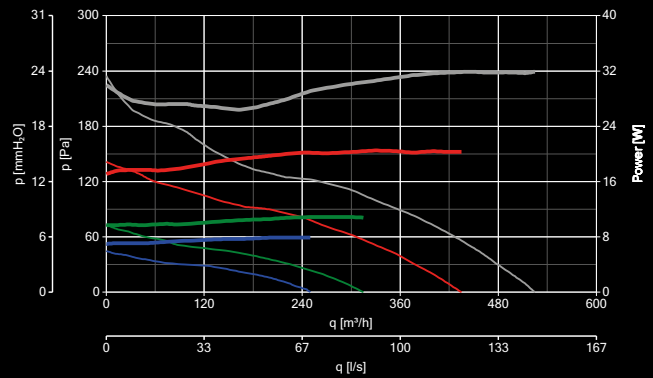

LINEO 200 QUIET ES

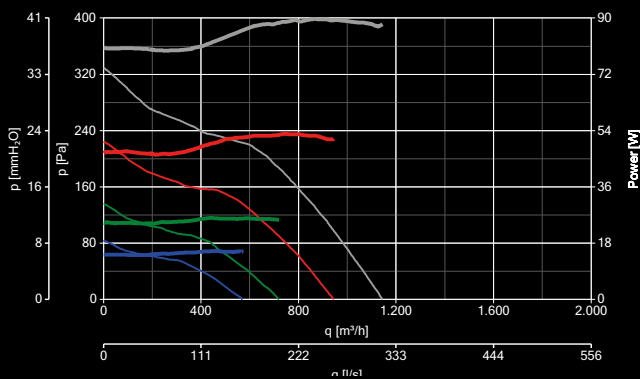

LINEO 250 QUIET ES

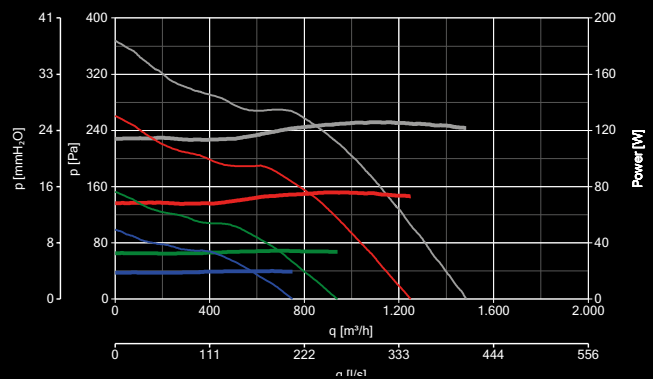



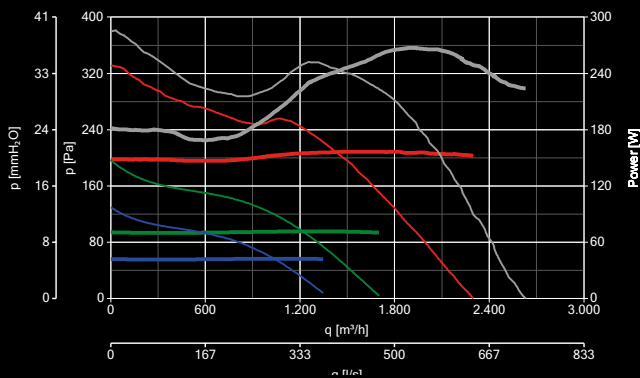

LINEO 315 QUIET ES



- | CONSUMPTION | | PERFORMANCE | |
|-------------|-----|-------------|-----|
| — | 10V | — | 10V |
| — | 8V | — | 8V |
| — | 6V | — | 6V |
| — | 4V | — | 4V |

CONTROLLERS - LINEO QUIET ES

MODELS	DESCRIPTION	CODE	PRODUCT
	POT-IT - POTENTIOMETER COMPATIBLE WITH FLUSHMOUNTING IN UNI 503 ELECTRIC BOX	12826	17170 - 17171 - 17172 - 17173 - 17174 17175 - 17176
	POT - POTENTIOMETER COMPATIBLE WITH FLUSHMOUNTING IN DIN ELECTRIC BOX	12828	17170 - 17171 - 17172 - 17173 - 17174 17175 - 17176
	DUO - 2 SPEED SELECTOR	22914	ALL PRODUCTS
	C TEMP - TEMPERATURE SENSOR	12992	ALL PRODUCTS
	C SMOKE - AIR QUALITY SENSOR	12993	ALL PRODUCTS
	C HCS - HUMIDITY SENSOR	12994	ALL PRODUCTS
	C PIR - PASSIVE INFRARED SENSOR	12998	ALL PRODUCTS
	C TIMER - TIMER	12999	ALL PRODUCTS

ENERGY EFFICIENCY DATA REQUIRED BY REG. ERP N° 327/211

Attribute name	LINEO 250 QUIET ES 17175	LINEO 215 QUIET ES 17176
Overall efficiency (η)	50,53	59,06
Test category	D	D
Data at the point of maximum efficiency (η)	936	1619,4
Efficiency category	total	total
Efficiency grade (η)	70,5	75,8
Variable speed drive	Si	Si
Year of construction	2020	2020
Model number	17175	17176
Power at peak efficiency (kW)	0,125	0,253
Pressure at high efficiency point (Pa)	243,38	332,35
Maximum efficiency point speed (RPM)	2617	2350
Specific ratio	<1,04	<1,04





TECHNICAL AND PERFORMANCE DATA - LINEO QUIET*

Models	Code	V~50/60 HZ	W min/med/ max	A min/med/ max	RPM min/med/ max	Max Airflow		Max Pressure		Proteccion grade**	Max °C	KG
						m³/h min/med/max	l/s min/med/max	mmH₂O min/med/max	Pa min/med/max			
LINEO 100 QUIET	17160	220-240	11	0.09	1455	150	41.7	9	88.3	IP45	45	3,8
LINEO 100 T QUIET	17190		24	0.11	1880	200	55.6	11.5	112.8			
LINEO 125 QUIET	17161	220-240	11	0.09	1125	190	52.8	8	78.5	IP45	45	3,6
LINEO 125 T QUIET	17191		24	0.11	1475	250	69.4	10	98.1			
LINEO 150 QUIET	17162	220-240	24	0.14	1040	255	70.8	10.5	103	IP45	55	5,4
LINEO 150 T QUIET	17192		37	0.17	1430	350	97.2	15.5	152			
LINEO 160 QUIET	17163	220-240	24	0.14	1040	255	70.8	10.5	103	IP45	55	5,2
LINEO 160 T QUIET	17193		37	0.17	1430	350	97.2	15.5	152			
LINEO 200 QUIET	17164	220-240	50	0.34	1880	805	223.6	20.6	202	IPX5	50	8,6
LINEO 200 T QUIET	17194		80	0.42	2380	1045	290.3	26.3	257.9			
LINEO 250 QUIET	17165	220-240	95	0.42	1640	960	266.7	20.2	198.1	IPX5	50	13,4
			125	0.55	2320	1340	372.2	30.3	297.2			
LINEO 315 QUIET	17166	220-240	150	0.65	2750	1550	430.6	34.6	339.3	IPX5	50	28,3
			215	0.95	1930	2070	575	30.6	300.1			
LINEO 315 QUIET	17166	220-240	270	1.15	2360	2530	702.8	43.3	424.6	IPX5	50	28,3
			360	1.55	2705	2890	802.8	53.6	525.7			

* all data referred to supply at 50 Hz

** protection grade referred to ducted units

SOUND LEVELS - LINEO QUIET

Models	Code	SOUND POWER Lw dB (A)								
		INTAKE			SUPPLY			BREAKOUT		
		min	med.	max	min	med.	max	min	med.	max
LINEO 100 QUIET	17160	62.2	70.5	74.6	62.3	68.7	74.4	36.2	41.8	46.6
LINEO 100 T QUIET	17190									
LINEO 125 QUIET	17161	60.1	64.2	70.4	60.5	64.2	70.9	36.2	41.8	45.5
LINEO 125 T QUIET	17191									
LINEO 150 QUIET	17162	60.3	68.2	77.3	62.1	67.7	76	38.2	43.4	51.2
LINEO 150 T QUIET	17192									
LINEO 160 QUIET	17163	60.3	68.2	77.3	62.1	67.7	76	38.2	43.4	51.2
LINEO 160 T QUIET	17193									
LINEO 200 QUIET	17164	76.9	83.3	86.4	75.1	81.5	85	51.6	57.4	60.7
LINEO 200 T QUIET	17194									
LINEO 250 QUIET	17165	76.3	83.6	85.1	75	83.4	87.4	49.5	57	60.7
LINEO 315 QUIET	17166	82.8	87	91.7	82.8	87	89.8	58.8	62.9	65.9

Models	Code	SOUND PRESSURE LP dB(A)*								
		INTAKE			SUPPLY			BREAKOUT		
		min	med.	max	min	med.	max	min	med.	max
LINEO 100 QUIET	17160	44.6	52.9	57.1	44.8	51.2	56.9	15.7	21.3	26.1
LINEO 100 T QUIET	17190									
LINEO 125 QUIET	17161	42.6	46.7	52.9	43	46.6	53.4	15.6	21.1	25
LINEO 125 T QUIET	17191									
LINEO 150 QUIET	17162	42.8	50.7	59.7	44.5	50.1	58.5	17.6	22.9	30.7
LINEO 150 T QUIET	17192									
LINEO 160 QUIET	17163	42.8	50.7	59.7	44.5	50.1	58.5	17.6	22.9	30.7
LINEO 160 T QUIET	17193									
LINEO 200 QUIET	17164	59.3	65.8	68.8	57.6	64	67.5	31	36.9	40.2
LINEO 200 T QUIET	17194									
LINEO 250 QUIET	17165	58.8	67.6	71.5	57.5	65.9	69.9	29	36.5	40.1
LINEO 315 QUIET	17166	66.8	71	74.2	65.3	69.5	72.3	38.3	42.4	45.4

* calculated in free field conditions at 3 m distance

DIMENSIONS - LINEO QUIET

Models	Code	A	B	C	Ø D	E	F	G	H	L	Ø M	N	VERSION
LINEO 100 QUIET	17160												
LINEO 100 T QUIET	17190	210	294.5	639	97	130	235	135	120	67.5	5.5	320	A
LINEO 125 QUIET	17161												
LINEO 125 T QUIET	17191	210	294.6	504.5	122	130	235	135	120	67.5	5.5	320	A
LINEO 150 QUIET	17162												
LINEO 150 T QUIET	17192	232	320.5	685	147	145	261.5	170	132	85	5.5	360	A
LINEO 160 QUIET	17163												
LINEO 160 T QUIET	17193	232	320.5	570	156.5	145	261.5	170	135	85	5.5	360	A
LINEO 200 QUIET	17164												
LINEO 200 T QUIET	17194	322.5	417.5	625.5	194.5	195	363.5	190	120	155	5.5	510	B
LINEO 250 QUIET	17165												
LINEO 250 QUIET	17165	318	412	751.5	243	189.5	363.5	200	70	170	6.5	604.5	B
LINEO 315 QUIET	17166												
LINEO 315 QUIET	17166	415.5	496.5	940	307	244	441	309	110	255	8.5	780	B

VERSION A

LINEO 100 QUIET - LINEO 100 T QUIET - LINEO 125 QUIET - LINEO 125 T QUIET
LINEO 150 QUIET - LINEO 150 T QUIET - LINEO 160 QUIET - LINEO 160 T QUIET

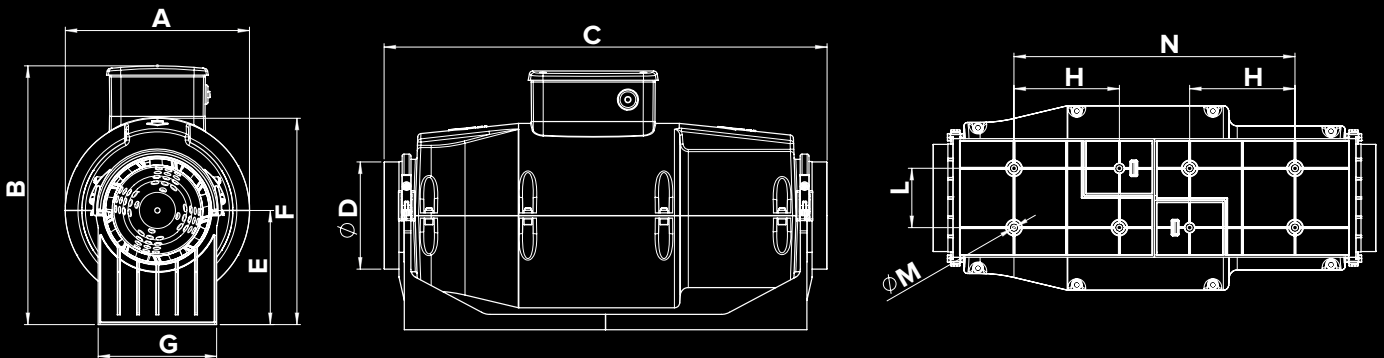

VERSION B

LINEO 200 QUIET - LINEO 200 T QUIET - LINEO 250 QUIET - LINEO 315 QUIET

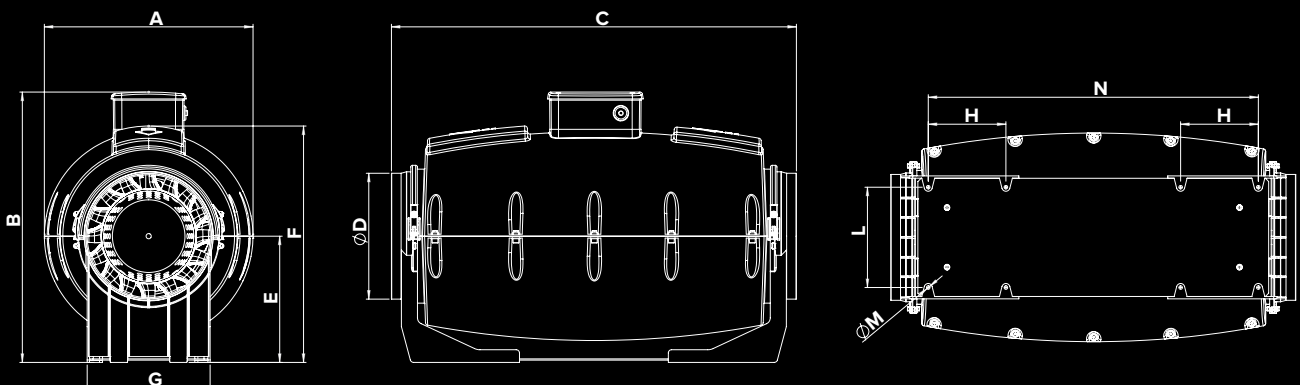



LINEO QUIET RANGE NEW

In-line mixed flow fans equipped with AC motors

PERFORMANCE AND ABSORPTION CURVES - LINEO QUIET

LINEO 100 QUIET - LINEO 100 T QUIET

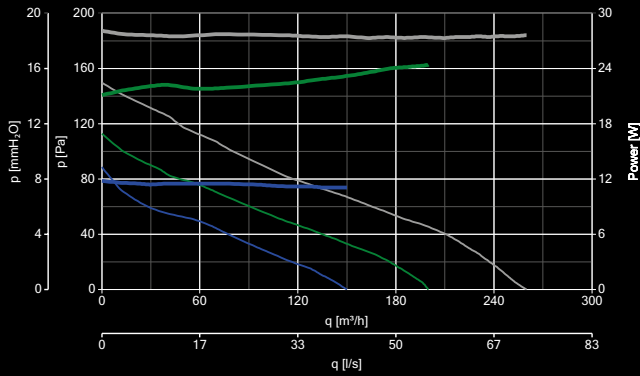

LINEO 125 QUIET - LINEO 125 T QUIET

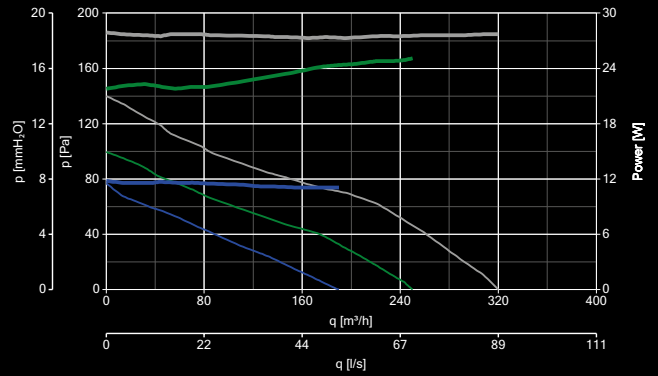

LINEO 150 QUIET - LINEO 150 T QUIET

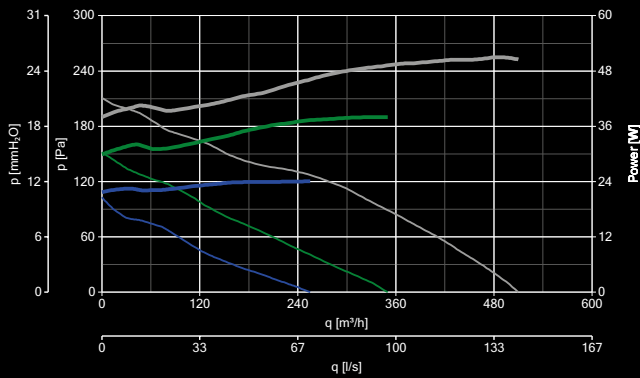

LINEO 160 QUIET - LINEO 160 T QUIET

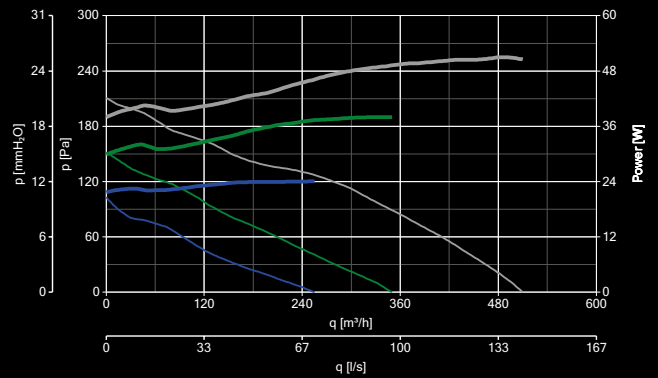

LINEO 200 QUIET - LINEO 200 T QUIET

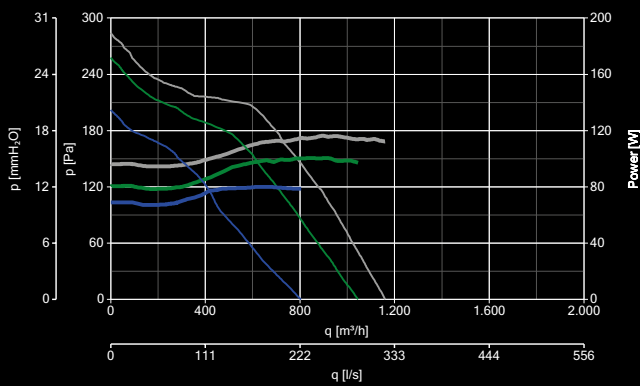

LINEO 250 QUIET

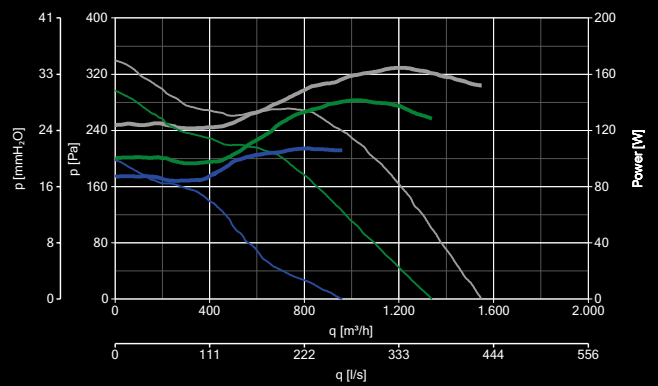



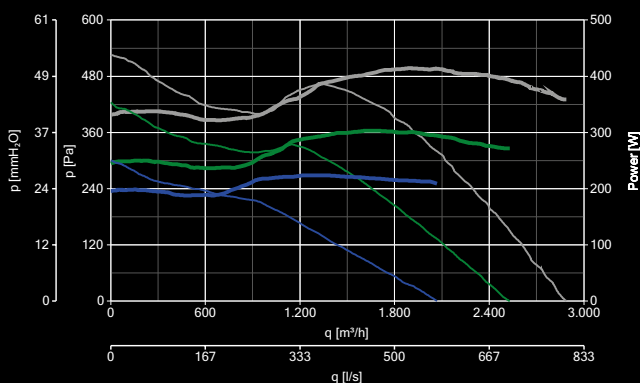





LINEO 315 QUIET



CONSUMPTION PERFORMANCE
— 10V — 10V
— 6V — 6V
— 4V — 4V

CONTROLLERS - LINEO QUIET

MODELS	DESCRIPTION	CODE	PRODUCT
	C5 0.5 - 5 SPEED CONTROLLER	12987	17160 - 17161 - 17162 - 17163 - 17164 17165 - 17166
	C 1.5 - ELECTRONIC SPEED CONTROLLER 1.5 A	12966	17160 - 17161 - 17162 - 17163 - 17164 17165 - 17166
	C 2.5 - ELECTRONIC SPEED CONTROLLER 2.5 A	12967	17165 - 17166
	KIT SCB5 - CONVERTS SCR5 TO A BUILT-IN VERSION	22483	12987 - 12966 - 12967
	KIT SCB - BUILT-IN CONTROLLER ADAPTOR	22481	12987 - 12966 - 12967
	TRIO-LINEO 503 - 3 SPEED SELECTOR	12891	17160 - 17161 - 17162 - 17163 - 17164 17165 - 17166 - 17190 - 17191 17192 17193 - 17194
	C TEMP - TEMPERATURE SENSOR	12992	ALL PRODUCTS
	C SMOKE - AIR QUALITY SENSOR	12993	ALL PRODUCTS
	C HCS - RELATIVE HUMIDITY SENSOR	12994	ALL PRODUCTS
	C PIR - PASSIVE INFRARED SENSOR	12998	ALL PRODUCTS
	C TIMER - TIMER	12999	ALL PRODUCTS

ENERGY EFFICIENCY DATA REQUIRED BY REG. ERP N° 327/211

Attribute name	LINEO 250 QUIET 17165	LINEO 315 QUIET 17166
Overall efficiency (η)	41,03	48,17
Test category	C	C
Data at the point of maximum efficiency (η)	925,9	1736,62
Efficiency category	static	static
Efficiency grade (η)	60,1	62,7
Variable speed drive	No	No
Year of construction	2020	2020
Model number	17165	17166
Power at peak efficiency (kW)	0,154	0,411
Pressure at high efficiency point (Pa)	245,8	410,60
Maximum efficiency point speed (RPM)	2793	2630
Specific ratio	1	1





LINEO RANGE

In-line mixed flow fans

The LINEO range products are fitted with multi speed induction motors.

THE BEST COMPROMISE AMONG
PERFORMANCE, POWER CONSUMPTION
AND NOISE EMISSION.



EASY AND FLEXIBLE INSTALLATION

KEY FEATURES

- Complete range, 26 models with a nominal diameter between 100 mm and 315 mm, 18 equipped with AC motors and 8 equipped with brushless EC motors.
- With or without timer and silenced.
- Flexibility and ease of installation ideal for your specific performance-related requirements, consumption, needs and operating costs.



easy

MAINTENANCE

ELECTRIC BOX
Produced in a material
granting electrical and
fire resistance

INLET NOZZLE
Dimensioned to sustain
the product in the wall and
ceiling installation



DIVERGENT ELEMENT
It helps the impeller to increase
the performance

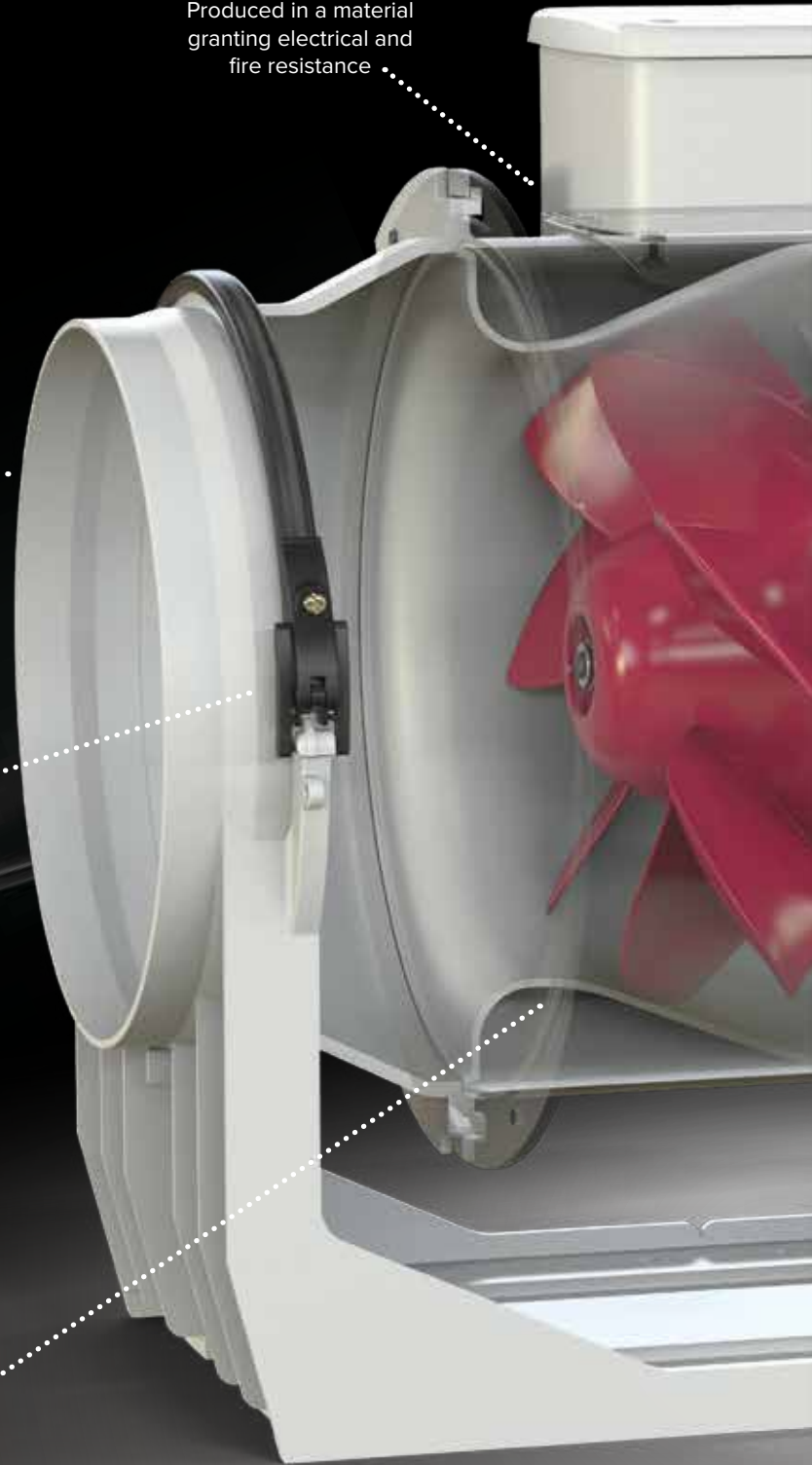

NEW

LINEO RANGE

In-line mixed flow fans



IMPELLER

Designed to reach the ERP efficiency levels

PROTECTIVE COVER

It corrects the airflow after the impeller and the rectifier, avoiding energy losses due to vortices

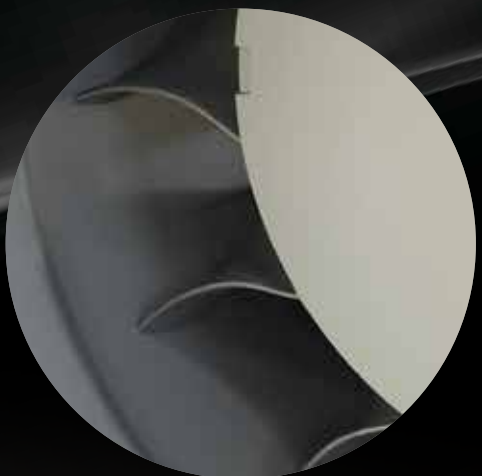

OUTLET NOZZLE

Dimensioned to sustain the product in the wall and ceiling installation

RECTIFIER BLADES

Designed with the impeller to rectify the airflow and avoid flow problems on the downstream part of the product

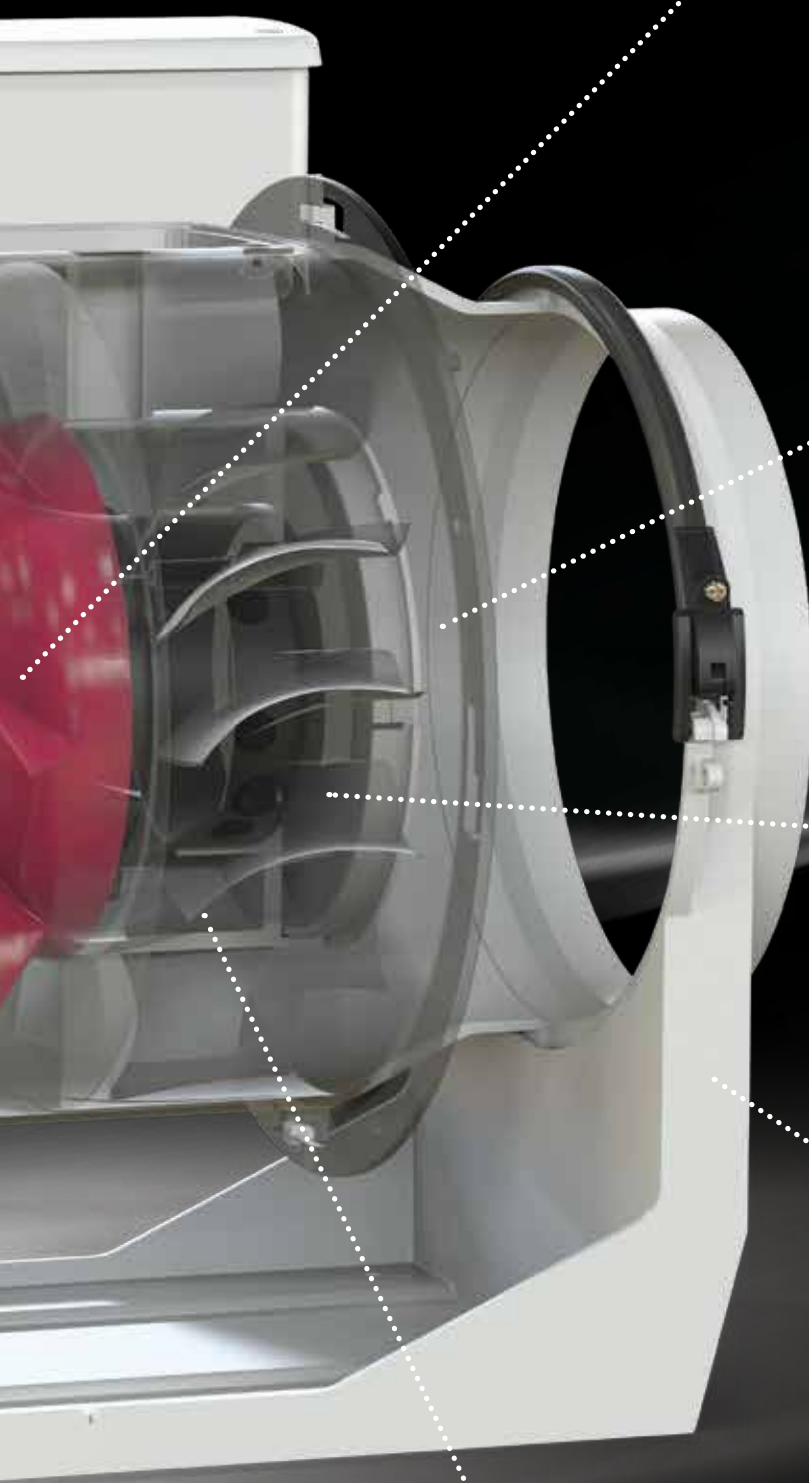

TECHNICAL AND PERFORMANCE DATA - LINEO*

Models	Code	V ~ 50/60HZ	W min/max	A min/max	RPM min/max	Max Airflow		Max Pressure		Sound Pressure Lp dB (A)**	Protecion grade***	Max °C	KG
						m ³ /h min/max	l/s min/max	mmH ₂ O min/max	Pa min/max				
LINEO 100	17144	220-240	20	0,09	1520	180	50	13	127.5	30.7	IP44	60	1.8
LINEO 100 T	17185		23	0,11	2030	255	70,8	16.5	161.9	39.4			
LINEO 100 Q	17143	220-240	12	0,05	1860	155	43.1	6.5	63.8	29.4	IP44	60	1.8
LINEO 100 Q T	17184		15	0,9	2450	200	55.6	7.5	73.6	37.9			
LINEO 125	17145	220-240	25	0,11	1570	250	69.4	13	127.5	33.9	IP44	60	1.8
LINEO 125 T	17186		33	0,15	2140	365	101.4	17	166.8	43			
LINEO 150	17146	220-240	40	0,18	1580	385	106.9	21	206	41.4	IP44	60	2.5
LINEO 150 T	17187		58	0,26	2100	550	152.8	27	264.9	50.5			
LINEO 160	17147	220-240	40	0,18	1580	385	106.9	21	206	41.7	IP44	60	2.8
LINEO 160 T	17188		58	0,26	2100	550	152.8	27	264.9	50.8			
LINEO 200 Q	17148	220-240	45	0,22	1780	700	194.4	13	127.5	39.6	IP44	60	4.3
LINEO 200 Q T	17189		75	0,37	2740	950	263.9	29	284.5	49.0			
LINEO 250 Q	17149	220-240	85	0,40	1850	720	200	34	333.5	49.1	IP44	60	5.9
LINEO 250 Q T	17197		110	0,50	2550	990	275	53	519.9	56.2			

* All data refered to supply at 50 Hz

** Calculated in free field conditions at 3 m distance

*** Protection refered to ducted units

Models	Code	V ~ 50 HZ	W min/med/ max	A min/med/ max	RPM min/med/ max	Max Airflow		Max Pressure		Protecion grade***	Max °C	KG
						m ³ /h min/med/max	l/s min/med/max	mmH ₂ O min/med/max	Pa min/med/max			
NEW LINEO 200	17180	220 - 240	80	0.34	1925	815	226.4	21.5	210.9	IPX5	50	4,9
NEW LINEO 200 T	17177		95	0.42	2450	1025	284.7	27.3	267.7			
NEW LINEO 250	17181	220 - 240	90	0.41	1500	725	201	13.9	136.5	IPX5	50	5,3
			120	0.54	2240	1145	318	29	284.4			
			145	0.63	2730	1440	400	37.2	364.8			
NEW LINEO 315	17182	220 - 240	190	1.14	1770	1590	442	27.1	265.8	IPX5	50	9,5
			260	1.57	2300	2115	588	42.2	413.9			
			360	1.60	2690	2590	719	55.4	543.3			

SUOND LEVELS - LINEO 200 - 250 - 315

Models	Code	SOUND POWER Lw dB (A)										
		INTAKE			SUPPLY			BREAKOUT				
		min	med.	max	min	med.	max	min	med.	max		
LINEO 200	17180											
LINEO 200 T	17177	80	86.4	89.5	78.6	74.9	88.2	57.4	63.7	67.5		
LINEO 250	17181	73.6	83.3	88.2	72.2	81.7	86.4	52.4	60	64		
LINEO 315	17182	82.6	88.7	92	82	88.2	91.8	60.1	66.3	69.5		

Models	Code	SOUND PRESSURE LP dB(A)*										
		INTAKE			SUPPLY			BREAKOUT				
		min	med.	max	min	med.	max	min	med.	max		
LINEO 200	17180											
LINEO 200 T	17177	62.5	68.8	72	61.1	67.4	70.7	36.9	43.1	46.9		
LINEO 250	17181	56.1	65.8	70.7	54.6	64.2	68.8	31.9	39.5	43.5		
LINEO 315	17182	65	71.1	74.5	64.5	70.6	74.2	39.6	45.8	49		

* Calculated in free field conditions at 3 m distance

DIMENSIONS - LINEO

Models	Code	A	B	C	Ø D	E	F	G	H	L	Ø M	N	VERSION
LINEO 100	17144	188.5	211	303	96	101.5	189	90	80	60	5.5	-	A
LINEO 100 T	17185	188.5	211	303	96	101.5	189	90	80	60	5.5	-	A
LINEO 100 Q	17143	156	174	231	96	82	152	95	47.5	51.5	4.5	-	B
LINEO 100 Q T	17184	156	174	231	96	82	152	95	47.5	51.5	5.5	-	B
LINEO 125	17145	188.5	211	258	122	101.5	189	90	80	60	5.5	-	A
LINEO 125 T	17186	188.5	211	258	122	101.5	189	90	80	60	5.5	-	A
LINEO 150	17146	214.5	234	294	146	112.5	212	110	80	60	5.5	-	A
LINEO 150 T	17187	214.5	234	294	146	112.5	212	110	80	60	5.5	-	A
LINEO 160	17147	214.5	234	272.5	156	112.5	212	110	80	60	5.5	-	A
LINEO 160 T	17188	214.5	234	272.5	156	112.5	212	110	80	60	5.5	-	A
LINEO 200	17180	270	373	396	194.5	195	330	190	155	120	5.5	-	C
LINEO 200 T	17177	270	373	396	194.5	195	330	190	155	120	5.5	280	C
LINEO 200 Q	17148	234.5	266	300	196	125.5	235	140	100	94	5.5	-	A
LINEO 200 Q T	17189	234.5	266	300	196	125.5	235	140	100	94	5.5	-	A
LINEO 250	17181	300	378	322	243	190	329	200	170	70	5.5	174.5	C
LINEO 250 Q	17149	300	322	385	247	152.5	292	176.5	145	140	5.5	-	A
LINEO 250 Q T	17189	300	322	385	247	152.5	292	176.5	145	140	5.5	174.5	A
LINEO 315	17182	373	446	420	307	224	398	309	255	110	8.5	259.5	C

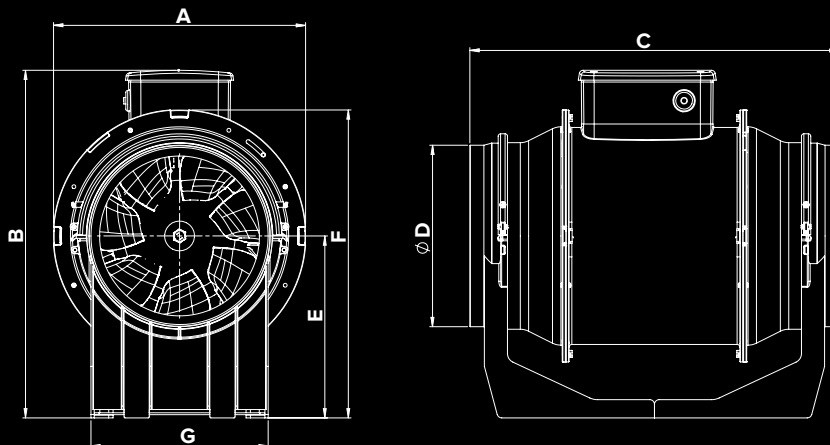

VERSION A

LINEO 100 - 100 T - LINEO 125 - 125 T
 LINEO 150 - 150 T - LINEO 160 - 160 T
 LINEO 200 Q - 200 Q T
 LINEO 250 Q - 250 Q T

VERSION B

LINEO 100 Q
 LINEO Q T

VERSION C

LINEO 200 - 200 T - LINEO 250 - LINEO 315

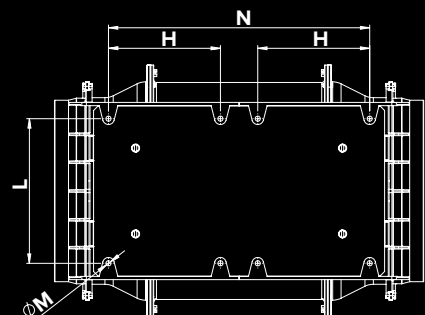
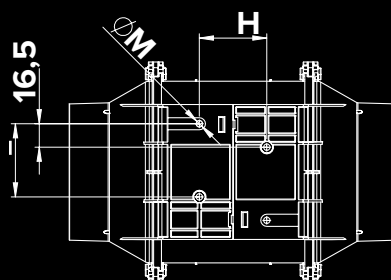
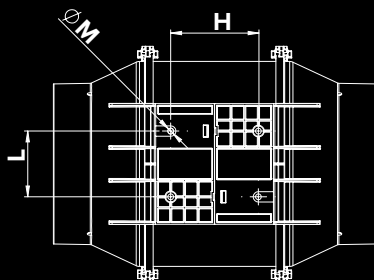

PERFORMANCE AND ABSORPTION CURVES - LINEO

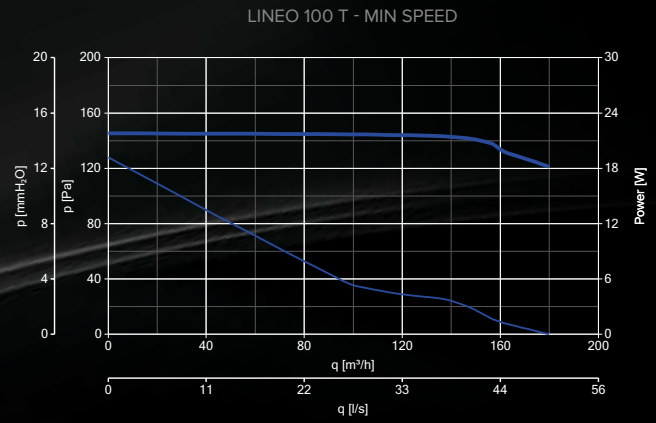
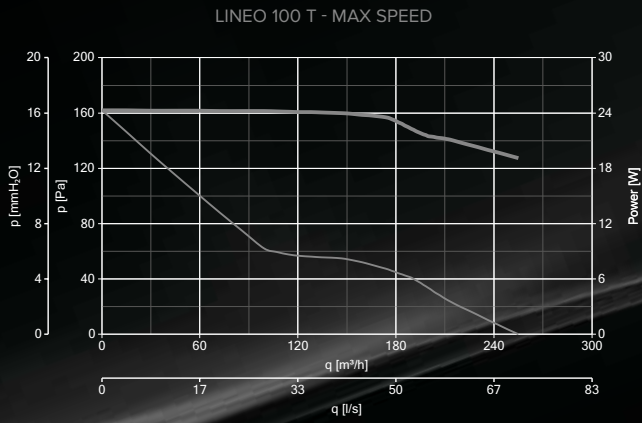
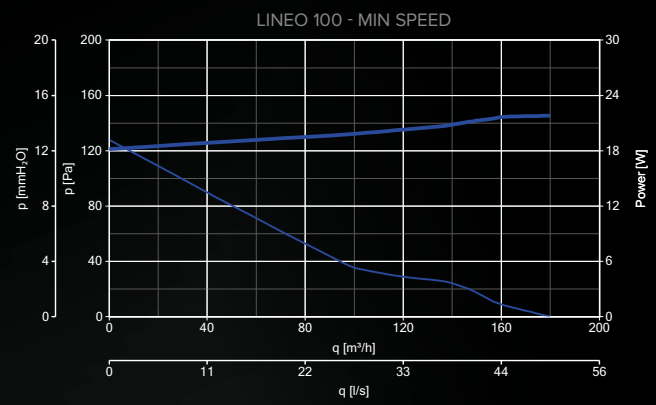
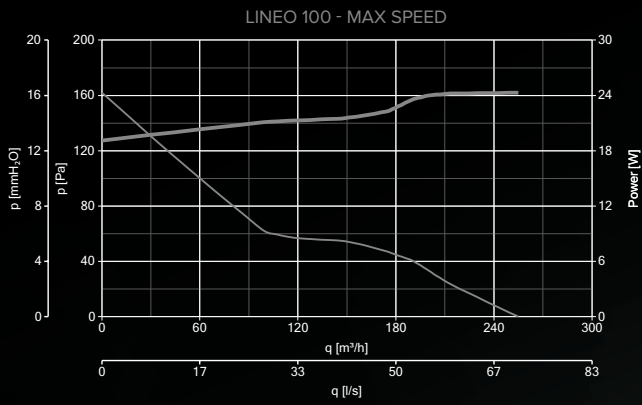

CONSUMPTION
 — max
 — min

PERFORMANCE
 — max
 — min

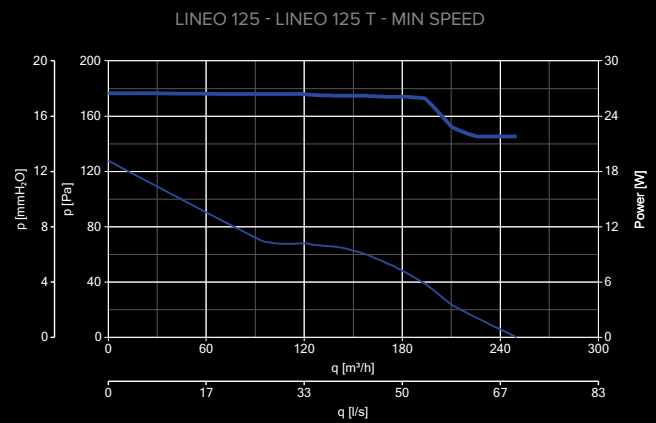
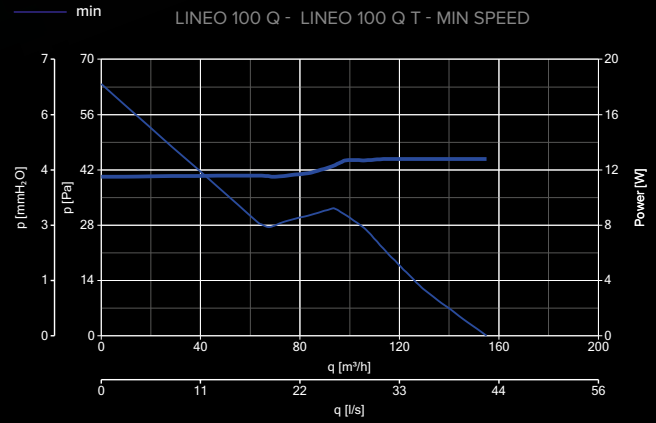
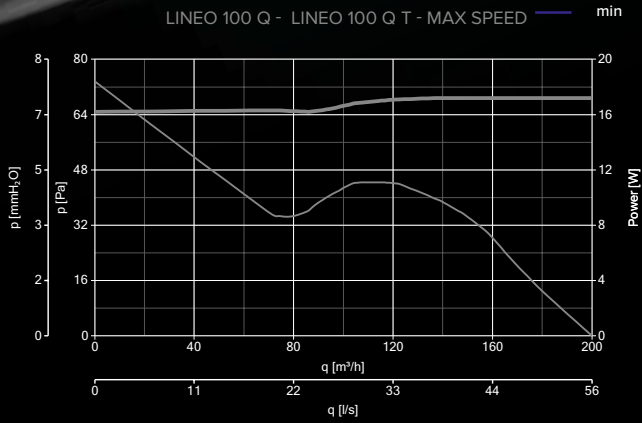

PERFORMANCE AND ABSORPTION CURVES - LINEO

LINEO 150 - LINEO 150 T - MAX SPEED

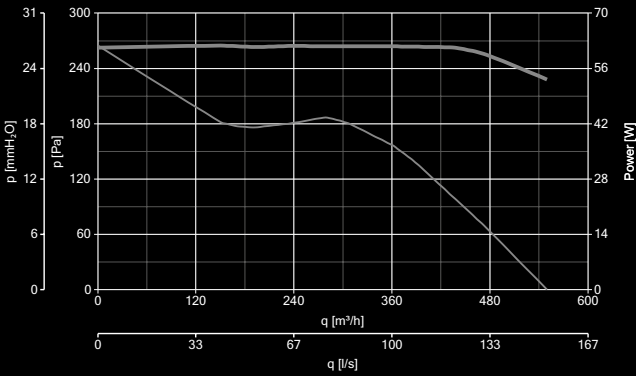

LINEO 150 - LINEO 150 T - MIN SPEED

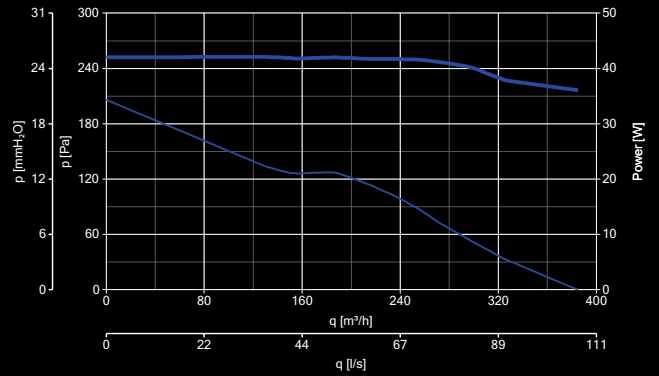

LINEO 160 - LINEO 160 T - MAX SPEED

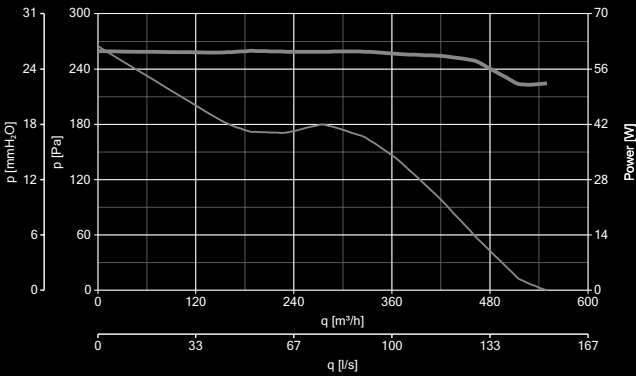

LINEO 160 - LINEO 160 T - MIN SPEED

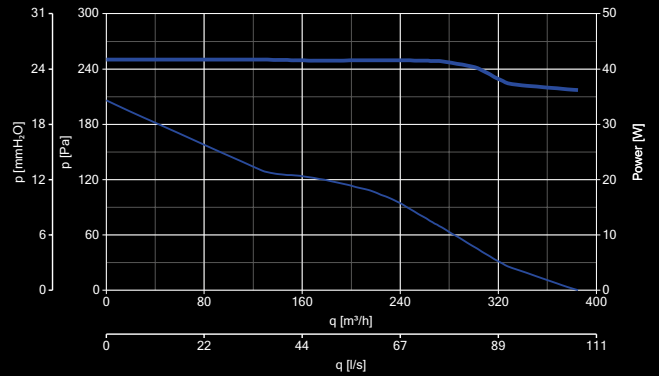

CONSUMPTION
— max
— min

PERFORMANCE
— max
— min

LINEO 200 Q - LINEO 200 Q T - MAX SPEED

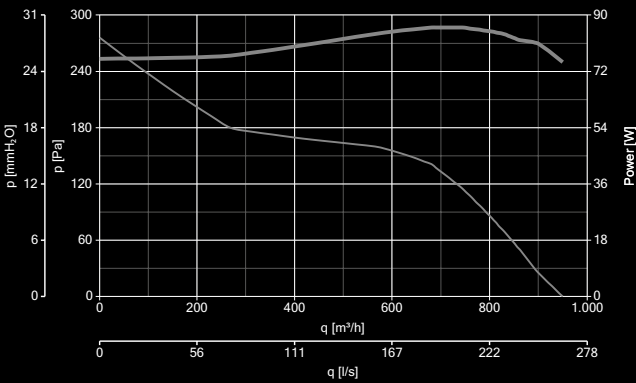

LINEO 200 Q - LINEO 200 Q T MIN SPEED

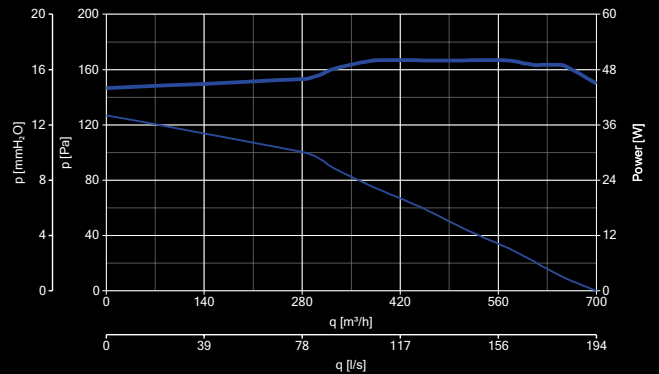

LINEO 250 Q - LINEO 250 Q T - MAX SPEED

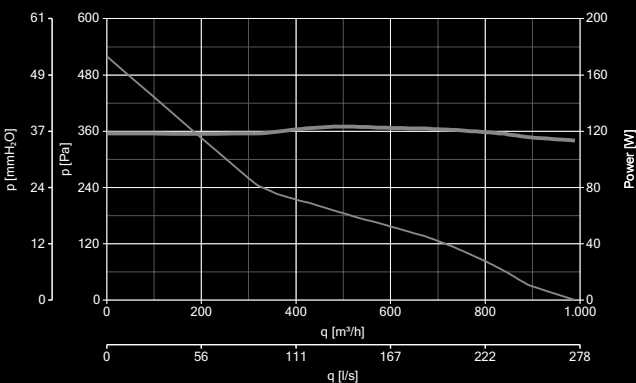

LINEO 250 Q - LINEO 250 Q T - MAX SPEED

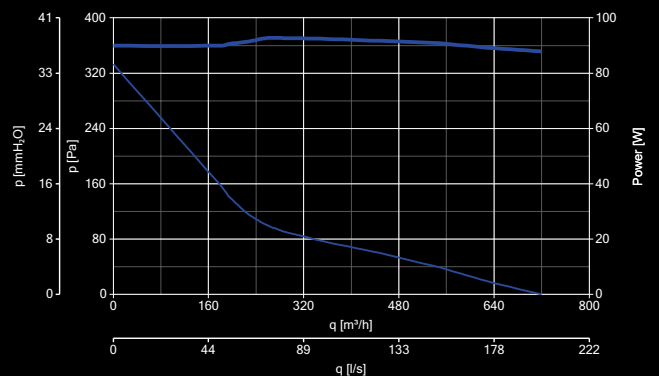

PERFORMANCE AND ABSORPTION CURVES - LINEO

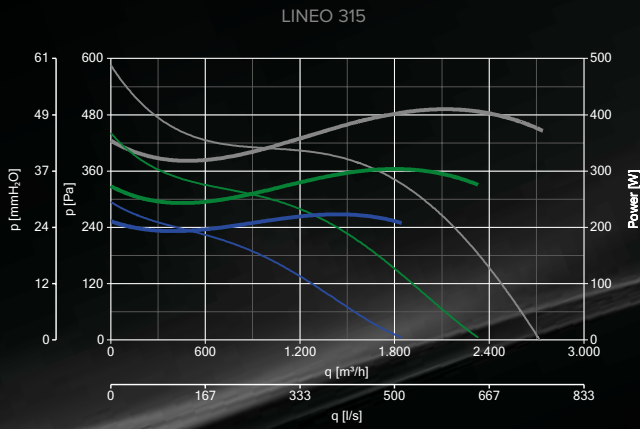
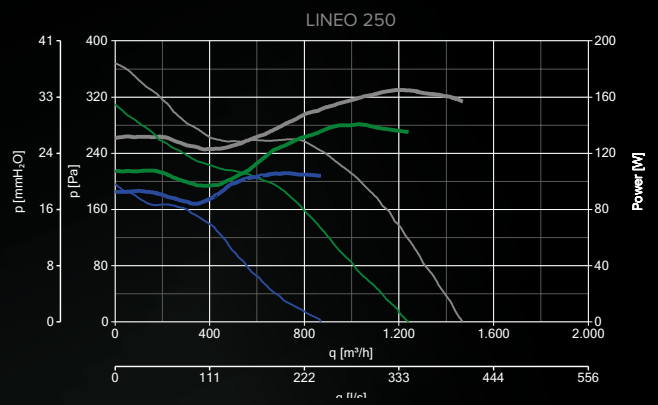
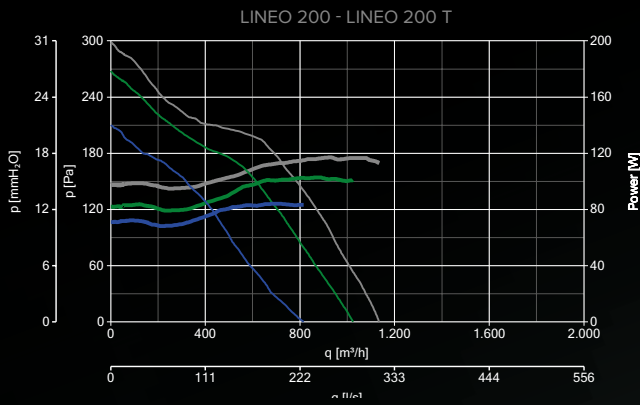

CONSUMPTION	PERFORMANCE
— MAX	— MAX
— MID	— MID
— MIN	— MIN

NEW

LINEO RANGE

In-line mixed flow fans equipped with AC motors



ENERGY EFFICIENCY DATA REQUIRED BY REG. ERP N° 327/211

Attribute name	LINEO 250 17181	LINEO 315 17166
Overall efficiency (η)	39,02	44,19
Test category	C	C
Data at the point of maximum efficiency (η)	857,5	1667,8
Efficiency category	statica	statica
Efficiency grade (η)	58,2	58,9
Variable speed drive	No	No
Year of construction	2020	2020
Model number	17181	17182
Power at peak efficiency (kW)	0,150	0,395
Pressure at high efficiency point (Pa)	246,11	376,99
Maximum efficiency point speed (RPM)	2777	2650
Specific ratio	1	1

TECHNICAL AND PERFORMANCE DATA - LINEO ES

Models	Code	V ~ 50/60HZ	W		A		RPM		Max Airflow		Max Pressure		Proteccion grade***	Max °C	KG
			4/6/8/10V	4/6/8/10V	4/6/8/10V	4/6/8/10V	m³/h	l/s	mmH₂O	Pa					
			4/6/8/10V	4/6/8/10V	4/6/8/10V	4/6/8/10V	4/6/8/10V	4/6/8/10V	4/6/8/10V	4/6/8/10V					
LINEO 100 ES	17159	220 - 240	6.5	0.07	1070	140	38.9	3.7	36.3	IP45	60	2.3			
			8.7	0.09	1345	175	48.6	6.1	59.8						
			16	0.15	1900	250	250	11.4	111.8						
			20	0.20	2220	305	84.7	26.4	258.9						
LINEO 100 Q ES	17158	220 - 240	4.5	0.05	900	60	16.7	0.9	8.8	IP45	60	1.8			
			5.5	0.06	1235	80	22.2	1.7	16.7						
			9	0.08	2070	145	40.3	4.3	42.2						
			19	0.18	3230	235	65.3	9.8	96.1						
LINEO 125 ES	17178	220 - 240	7	0.07	1090	170	47.2	3.8	37.3	IP45	60	2.2			
			10	0.10	1395	220	61.1	6.5	63.7						
			18	0.17	1940	315	87.5	11.8	115.7						
			25	0.25	2270	370	102.8	30.2	296.2						
LINEO 150 ES	17179	220 - 240	11	0.10	1260	290	80.6	8.5	83.4	IP45	60	2.6			
			17	0.16	1595	370	102.8	13.8	135.3						
			34	0.30	2125	500	138.9	22.7	222.6						
			55	0.50	2480	590	163.9	44.2	433.5						
LINEO 160 ES	17183	220 - 240	12	0.11	1305	300	83.3	9	9	IP45	60	2.7			
			19	0.17	1645	385	106.9	14.8	145.1						
			37	0.33	2165	510	141.7	23.5	230.5						
			60	0.55	2625	630	175	47.2	462.9						
NEW LINEO 200 ES	17167	220 - 240	15.8	0.19	1380	560	155.6	9.2	90.2	IP45	50	4.6			
			25.7	0.28	1700	700	194.4	14.4	141.2						
			52.8	0.53	2220	920	255.6	24	235.4						
			90	0.80	2680	1100	305.6	34.9	342.4						
NEW LINEO 250 ES	17168	220 - 240	20	0.17	2270	755	209.7	11	107.9	IP45	50	5			
			35	0.28	1695	935	259.7	16.9	165.7						
			75	0.61	1370	1235	343.1	28.9	283.4						
			126	1.00	2680	1475	409.7	40.4	396.2						
NEW LINEO 315 ES	17169	220 - 240	45	0.37	1300	1415	393.1	14.6	143.2	IP45	50	9.2			
			75	0.63	1600	1740	393.1	21.9	214.8						
			170	1.32	2130	2320	483.3	38.6	378.6						
			230	1.75	2370	2625	729.2	43	421.7						

* All data referred to supply at 50 Hz

*** Protection referred to ducted units

SOUND LEVELS - LINEO ES

SOUND POWER Lw dB (A)

Models	Code	INTAKE				SUPPLY				IRRADIATED			
		4V	6V	8V	10V	4V	6V	8V	10V	4V	6V	8V	10V
LINEO 100 ES	17159	63.3	69.4	78.2	82.6	62.1	68.4	77.5	82	35.5	39.5	47.8	52.3
LINEO 100 Q ES	17158	57.8	64.9	75.1	85.7	54.9	64.9	73.5	85.7	35.1	37.4	47.5	56.6
LINEO 125 ES	17178	64.1	68.2	76.7	81.4	63.6	68.6	77.5	81.5	36.8	40.5	48.8	52.2
LINEO 150 ES	17179	67.9	74.6	82.1	87.9	69.6	75.2	82.1	86.4	41.5	47.8	56.1	62.5
LINEO 160 ES	17183	68.4	76.4	83.1	87.5	69.1	76	82.8	86.9	42.4	49.4	57	62.3
LINEO 200 ES	17167	78.5	83.9	86.9	89.4	77.5	82.9	85.4	88.4	55.6	60.4	62.8	65
LINEO 250 ES	17168	74.2	79.1	85.1	88.9	74.4	79.2	84.9	88.5	49.5	54.3	61.4	64
LINEO 315 ES	17169	83.1	88	90.7	92.8	80.8	88.2	88.8	90	63	64.6	65.3	68.1

SOUND PRESSURE Lp dB(A)*

Models	Code	INTAKE				SUPPLY				IRRADIATED			
		4V	6V	8V	10V	4V	6V	8V	10V	4V	6V	8V	10V
LINEO 100 ES	17159	45.8	51.9	60.7	65.1	44.6	50.9	59.9	64.4	15	18.9	27.2	31.8
LINEO 100 Q ES	17158	40.2	47.3	57.6	68.2	37.3	47.4	56	68.1	14.6	16.9	27	36.1
LINEO 125 ES	17178	46.6	50.6	59.1	63.9	46	51.1	60	64	16.2	20	28.3	31.6
LINEO 150 ES	17179	50.4	57.1	64.6	70.3	52.1	57.7	64.5	68.9	21	27.2	35.5	41.9
LINEO 160 ES	17183	50.9	58.9	65.6	70	51.5	58.5	65.6	69.3	21.9	28.9	36.5	41.8
LINEO 200 ES	17167	60.9	66.4	69.4	71.9	60	65.3	67.9	70.8	35.1	39.9	42.3	44.5
LINEO 250 ES	17168	56.7	61.5	67.6	71.3	56.9	61.6	67.3	71	29	33.7	40.9	43.4
LINEO 315 ES	17169	65.6	70.4	73.2	75.3	63.3	70.6	71.2	72.4	42.5	44	44.8	47.5

* Calculated in free field conditions at 3 m distance

NEW

LINEO ES RANGE

In-line mixed flow fans equipped with EC Brushless motors



DIMENSIONS - LINEO ES

Models	Code	A	B	C	Ø D	E	F	G	H	L	Ø M	N	VERSION
LINEO 100 ES	17159	188.5	240	303	96	101.5	189	90	80	60	5.5	-	A
LINEO 100 Q ES	17158	156	205	231	96	82	152	95	47.5	51.5	4.5	-	B
LINEO 125 ES	17178	188.5	240	258	122	101.5	189	90	80	60	5.5	-	A
LINEO 150 ES	17179	214.5	265	294	146	112.5	212	110	80	60	5.5	-	A
LINEO 160 ES	17183	214.5	265	272.5	156	112.5	212	110	80	60	5.5	-	A
LINEO 200 ES	17167	270	372.5	396	194.5	195	330	190	155	120	5.5	280	C
LINEO 250 ES	17168	300	377.5	322	243	190	329	200	170	70	6.5	174.5	C
LINEO 315 ES	17169	373	506	420	307	224	398	309	255	110	8.5	259.5	C

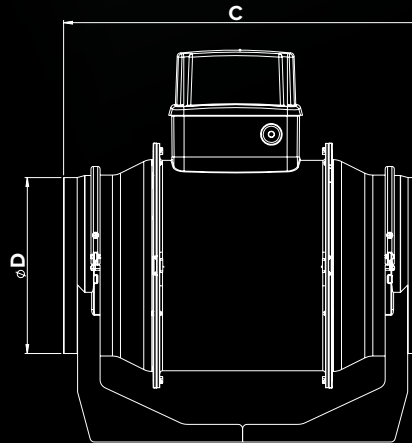
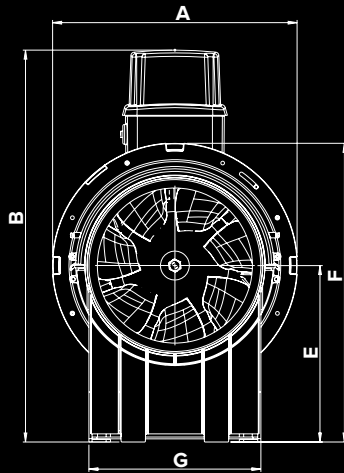

VERSION A

LINEO 100 ES - LINEO 125 ES
LINEO 150 ES - LINEO 160 ES

VERSION B

LINEO 100 Q ES

VERSION C



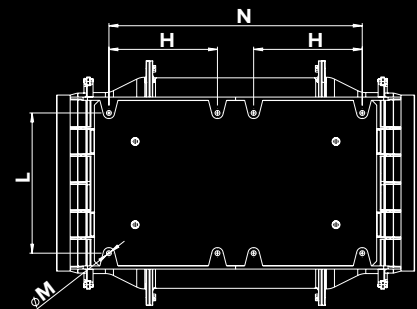
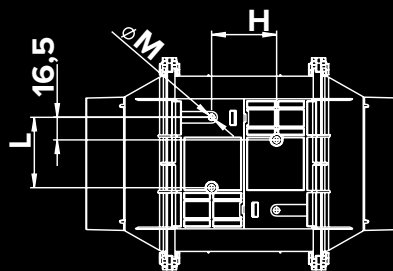
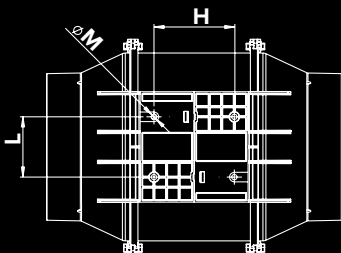



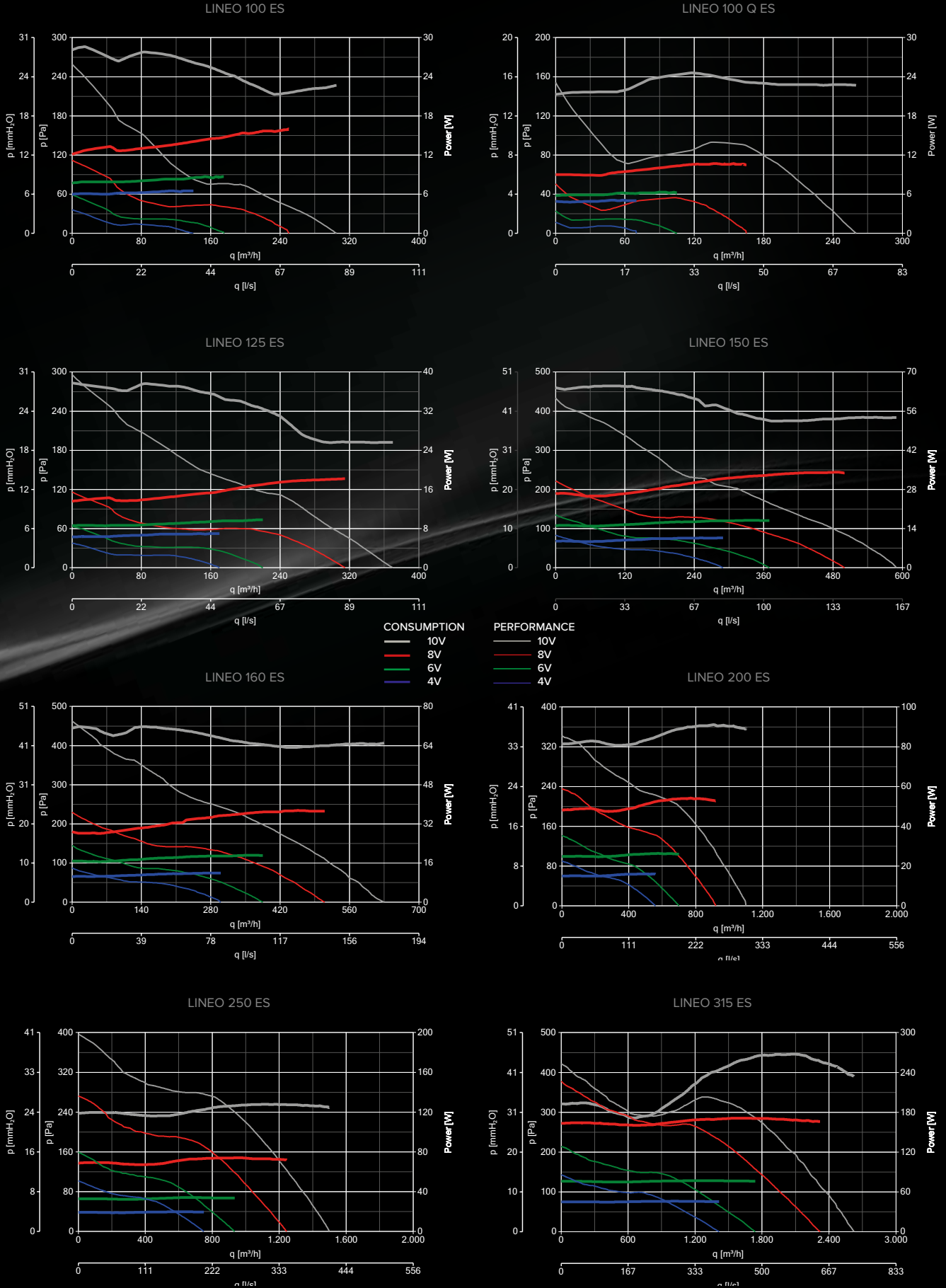



LINEO 200 ES - LINEO 250 ES
LINEO 315 ES



PERFORMANCE AND ABSORPTION CURVES - LINEO ES



CONTROLLERS - LINEO

MODELS	DESCRIPTION	CODE	PRODUCT
	C5 0.5 - 5 SPEED CONTROLLER	12987	17180
	C 1.5 - ELECTRONIC SPEED CONTROLLER 1.5 A	12966	17180
	C 2.5 - ELECTRONIC SPEED CONTROLLER 2.5 A	12967	17181 - 17182
	KIT SCB5 - CONVERTS SCR5 TO A BUILT-IN VERSION	22483	12987 - 12966 - 12967
	KIT SCB - BUILT-IN CONTROLLER ADAPTOR	22481	12987 - 12966 - 12967
	POT-IT - POTENTIOMETER COMATIBLE WITH FLUSHMOUNTING IN UNI 503 ELECTRIC BOX	12826	17158 - 17159 - 17179 - 17183 - 17187 17167 - 17168 - 17169
	POT - POTENTIOMETER COMATIBLE WITH FLUSHMOUNTING IN DIN ELECTRIC BOX	12828	17158 - 17159 - 17179 - 17183 - 17187 17167 - 17168 - 17169
	TRIO-LINEO 503 - 3 SPEED SELECTOR	12891	17181 - 17177 - 17182
	DUO - 2 SPEED SELECTOR	22914	17144 - 17185 - 17143 - 17184 - 17145 17186 - 17146 - 17187 - 17147 - 1718 17148 - 17189 - 17149 - 17197
	C TEMP - TEMPERATURE SENSOR	12992	ALL PRODUCTS
	C SMOKE - AIR QUALITY SENSOR	12993	ALL PRODUCTS
	C HCS - RELATIVE HUMIDITY SENSOR	12994	ALL PRODUCTS
	C PIR - PASSIVE INFRARED SENSOR	12998	ALL PRODUCTS
	C TIMER - TIMER	12999	ALL PRODUCTS

ACCESSORIES ON REQUEST - LINEO

MODELS	DESCRIPTION	CODE	PRODUCT	
		100	22584	
	LINEO-C - IN-LINE INSTALLATION KITS	125	22585	17159 - 17158
		150	22586	17178
		160	22587	17179
		160	22587	17183
		100	22577	
	LINEO-PF - SIDE BY SIDE INSTALLATION KITS	125	22578	17159 - 17158
		150	22579	17178
		160	22579	17179
		160	22581	17179
	LINEO-SF 500 - BRACKET FOR IN-LINE APPLICATION		22593	
			22593	17143 - 17184 - 17144 - 17185 - 17159 17158 - 17145 - 17186 - 17178 - 17146 17187 - 17179 - 17147 - 17188 - 17183 17148 - 17189 - 17180 - 17177 - 17167
	LINEO-SF 700 - BRACKET FOR IN-LINE APPLICATION		22594	
	LINEO-G - PROTECTION GRILLE	100	22701	17149 - 17197 - 17168 - 17169
		125	22702	17143 - 17184 - 17144 17185 - 17159 - 17158
		150	22703	17145 - 17186 - 17178
		160	22704	17146 - 17187 - 17179
		200	22705	17147 - 17188 - 17183
		250	22706	17148 - 17189 - 17180 - 17177 - 17167
		315	22707	17149 - 17197 - 17168

ENERGY EFFICIENCY DATA REQUIRED BY REG. ERP N° 327/211

Attribute name	LINEO 250 ES 17168	LINEO 315 ES 17169
Overall efficiency (η)	51,87	57,94
Test category	D	D
Data at the point of maximum efficiency (η)	962,9	1610,6
Efficiency category	statica	totale
Efficiency grade (η)	71,8	74,6
Variable speed drive	si	si
Year of construction	2020	2020
Model number	17168	17169
Power at peak efficiency (kW)	0,125	0,258
Pressure at high efficiency point (Pa)	243,08	334,45
Maximum efficiency point speed (RPM)	2658	2364
Specific ratio	<1,04	<1,04





VORTICE GROUP COMPANIES

VORTICE S.P.A

Strada Cerca, 2
Frazione di Zoate
20067 Tribiano
(Milan) Italy
Tel. (+39) 02 906991
Fax (+39) 02 90699625
vortice.com

VORTICE LIMITED

Beeches House-Eastern
Avenue Burton on Trent
DE13 0BB United Kingdom
Tel. (+44) 1283 492949
Fax (+44) 1283 544121
vortice.ltd.uk

VORTICE INDUSTRIAL S.R.L.

Via B. Brugnoli 3,
37063 Isola della Scala
(Verona) Italy
Tel. (+39) 045 6631042
Fax (+39) 045 6631039
vorticeindustrial.com

CASALS VENTILACIÓN AIR INDUSTRIAL S.L.

Ctra. Camprodon, s/n 17860
Sant Joan de les
Abadesses
(Girona) Spain
Tel. (+34) 972720150
casals.com

VORTICE LATAM S.A.

Bodega #6
Zona Franca Este Alajuela,
Alajuela 20101
Costa Rica
Tel. (+506) 2201 6934
vortice-latam.com

VORTICE VENTILATION SYSTEM

(Changzhou) Co.LTD
No. 388 West Huanghe Road
Building 19, Changzhou
Post Code: 213000 China
Tel. (+86) 0519 88990150
Fax (+86) 0519 88990151
vortice-china.com

The descriptions and illustrations in this catalogue are intended to be indicative and not binding. Without prejudice to the essential characteristics of the products described and illustrated here, VORTICE reserves the right to make, at any time and without notice, changes to parts, aesthetic details or supply of accessories to its products that are deemed to be appropriate for improvement or for any construction or commercial requirement.

This printout completely cancels and replaces all the previous ones

code 5.170.084.704 - May 2022